

REV.	BY	DESCRIPTION	DATE
Draft	NJF	Draft	08/14/2008
Draft	NJF	Updated draft	05/22/2009
Draft	NJF	Draft version for pre-release review.	08/31/2009
-	NJF	Baseline for initial PLM release.	09/28/2009
A	RJB	Refer to Rev A redline PDF in PLM.	07/16/2012

Revision: A  
Date: July 16, 2012



THE JOHNS HOPKINS UNIVERSITY  
**APPLIED PHYSICS LABORATORY**  
11100 JOHNS HOPKINS ROAD, LAUREL, MARYLAND 20723-6099

## Radiation Belt Storm Probes (RBSP) Science Data Management Plan

	FSCM NO. <b>88898</b>	SIZE <b>A</b>	DRAWING NO. <b>7417-9129</b>	REV. <b>A</b>
	SCALE	DO NOT SCALE PRINT	SHEET 1 of 78	

## Technical Content Approval

**Prepared/Approved by:**

Nicola J. Fox  
RBSP Deputy Project Scientist

Robin J. Barnes  
RBSP SOC Coordinator

**Approved by:**

Richard J. Fitzgerald  
RBSP Project Manager

Barry H. Mauk  
RBSP Project Scientist

James M. Stratton  
RBSP Mission Systems Engineer

Deborah A. Clancy  
RBSP Software Systems Engineer

Kim A. Cooper  
RBSP Deputy Project Manager, Instrument

David A. Artis  
RBSP Data Systems Engineer

Raymond J. Harvey  
RBSP Ground Segment Systems Engineer

Richard J. Pfisterer  
Systems Assurance Manager

A Release stamp electronically affixed to the pages of this document certifies that the above personnel or designated alternates have approved this revision. Please refer to the APL Product Lifecycle Management System (PLM) for record of these approvals.

FSCM NO. <b>88898</b>	SIZE <b>A</b>	DRAWING NO. <b>7417-9129</b>	REV. <b>A</b>
SCALE	DO NOT SCALE PRINT	SHEET 2 of 78	

## Instrument Team Approvals

[Please SIGN and DATE within center of boxes while remaining away from text and enclosing lines]

<p><b>Harlan Spence</b> ECT PI [DATE]</p>	<p><b>Reiner Friedel</b> ECT SOC Lead [DATE]</p>
<p><b>John Wygant</b> EFW PI [DATE]</p>	<p><b>John Bonnell</b> EFW SOC Lead [DATE]</p>
<p><b>Craig Kletzing</b> EMFISIS PI [DATE]</p>	<p><b>Scott Bounds</b> EMFISIS SOC Lead [DATE]</p>
<p><b>Louis Lanzerotti</b> RBSPICE PI [DATE]</p>	<p><b>Jerry Manweiler</b> RBSPICE SOC Lead [DATE]</p>
<p><b>David Byers</b> PSBR PI [DATE]</p>	<p><b>T. Paul O'Brien</b> PSBR SOC Lead [DATE]</p>

FSCM NO. <b>88898</b>	SIZE <b>A</b>	DRAWING NO. <b>7417-9129</b>	REV. <b>A</b>
SCALE	DO NOT SCALE PRINT	SHEET 3 of 78	

## TABLE OF CONTENTS

<b>1</b>	<b>INTRODUCTION.....</b>	<b>7</b>
1.1	Purpose.....	7
1.2	Scope.....	7
1.3	Configuration Management.....	7
1.4	Applicable Documents and Constraints.....	7
<b>2</b>	<b>RBSP PROJECT OVERVIEW .....</b>	<b>9</b>
2.1	Payload and Mission.....	9
2.2	Mission-Level Science and Data Operations.....	11
2.2.1	Coordination of Science/data Activities .....	11
2.2.2	RBSP Mission Rules of the Road for Data Usage.....	11
2.2.3	Coordination of science/data activities between RBSP teams and other Heliophysics missions.....	12
<b>3</b>	<b>DATA PROCESSING.....</b>	<b>16</b>
3.1	Approach .....	16
3.2	Implementation .....	17
3.2.1	ECT .....	17
3.2.2	EFW .....	22
3.2.3	EMFISIS .....	25
3.2.4	RBSPICE .....	30
3.2.5	PSBR/RPS.....	34
<b>4</b>	<b>DATAPRODUCTS .....</b>	<b>36</b>
4.1	Definitions of Data .....	36
4.1.1	Definitions of Quick-look and Final data products.....	37
4.1.2	ECT.....	39
4.1.3	EFW .....	45
4.1.4	EMFISIS .....	46
4.1.5	RBSPICE .....	49
4.1.6	PSBR/RPS.....	50
4.2	Mapping of Data Product types.....	52
	Particles 52	
4.2.1	Magnetic Fields.....	53
4.2.2	Electric Field.....	53

FSCM NO. <b>88898</b>	SIZE <b>A</b>	DRAWING NO. <b>7417-9129</b>	REV. <b>A</b>
SCALE	DO NOT SCALE PRINT	SHEET 4 of 78	

4.2.3	Waves.....	54
<b>4.3</b>	<b>Magnetic FIELD Models.....</b>	<b>55</b>
<b>4.4</b>	<b>FILE FORMATS .....</b>	<b>55</b>
<b>4.5</b>	<b>FILENAME CONVENTIONS .....</b>	<b>56</b>
<b>4.6</b>	<b>Revision Control.....</b>	<b>57</b>
<b>4.7</b>	<b>Documentation .....</b>	<b>57</b>
4.7.1	ECT .....	57
4.7.2	EFW .....	57
4.7.3	EMFISIS .....	57
4.7.4	RBSPICE .....	58
4.7.5	PSBR.....	58
<b>4.8</b>	<b>Processing and Analysis Tools .....</b>	<b>59</b>
4.8.1	RBSP SCIENCE GATEWAY .....	59
4.8.2	ECT .....	60
4.8.3	EFW .....	63
4.8.4	EMFISIS .....	64
4.8.5	RBSPICE .....	65
4.8.6	PSBR.....	65
<b>5</b>	<b>DATA ARCHIVE .....</b>	<b>67</b>
<b>5.1</b>	<b>Storage and Archive Strategy .....</b>	<b>67</b>
5.1.1	ECT .....	67
5.1.2	EFW .....	67
5.1.3	EMFISIS .....	68
5.1.4	RBSPICE .....	68
5.1.5	PSBR.....	69
<b>6</b>	<b>DATA AVAILABILITY .....</b>	<b>70</b>
<b>6.1</b>	<b>Data Access Policy.....</b>	<b>70</b>
6.1.1	ECT .....	70
6.1.2	EFW .....	70
6.1.3	EMFISIS .....	70
6.1.4	RBSPICE .....	71
6.1.5	PSBR.....	71
<b>6.2</b>	<b>Data Release Schedule .....</b>	<b>71</b>
6.2.1	ECT .....	71
6.2.2	EFW .....	71
6.2.3	EMFISIS .....	72

FSCM NO. <b>88898</b>	SIZE <b>A</b>	DRAWING NO. <b>7417-9129</b>	REV. <b>A</b>
SCALE	DO NOT SCALE PRINT	SHEET 5 of 78	

6.2.4	RBSPICE .....	72
6.2.5	PSBR.....	73
<b>6.3</b>	<b>Data Catalogs .....</b>	<b>73</b>
6.3.1	ECT.....	73
6.3.2	The catalog function is to be handled by the Virtual Radiation Belt Observatory (ViRBO). EFW .....	73
6.3.3	EMFISIS .....	74
6.3.4	RBSPICE .....	74
6.3.5	PSBR.....	75
<b>APPENDIX A: ACRONYMS .....</b>		<b>76</b>

FSCM NO. <b>88898</b>	SIZE <b>A</b>	DRAWING NO. <b>7417-9129</b>	REV. <b>A</b>
SCALE	DO NOT SCALE PRINT		SHEET 6 of 78

# 1 INTRODUCTION

## 1.1 PURPOSE

The Radiation Belt Storm Probe (RBSP) Science Data Management Plan (SDMP) presents a high-level strategy for the generation, validation, and delivery of science data products by each of the RBSP instrument suite Science Operation Centers (SOCs). The plan also specifies policies and procedures for distributing data and data products to co-investigators, the wider science community, and the general public.

## 1.2 SCOPE

The plan defines the data processing approach and implementation, data and documentation products, data availability, and storage and archival strategies for the RBSP mission.

Specific aspects addressed in this plan are:

1. Definition of data products (including levels)
2. Definition of documentation products to be provided on datasets, instruments, calibration and algorithms.
3. Identification of publicly disseminated data
4. Method of distribution of data to the public
5. Schedule for making data publicly available.
6. Long term storage and archival plans.

## 1.3 CONFIGURATION MANAGEMENT

The data contained in this document represents the current definition of the Radiation Belt Storm Probe Mission Science Data Management Plan. This document, after formal release, shall be revised only through the formal change control procedures as described in the RBSP Configuration Management Plan.

## 1.4 APPLICABLE DOCUMENTS AND CONSTRAINTS

Level 1 Requirements for the Radiation Belt Storm Probes Mission	
7417-9013	RBSP Mission Requirements Document (MRD)
7417-9148	RBSP Science Team Allocated Requirements Document (STARD)
7417-9016	RBSP Concept of Operations
7417-9050	RBSP Mission Operations Center (MOC) to RBSP Science Operations Center (SOC) and Interface Control Document (ICD)
7417-9105	RBSP MOC Data Product Document

FSCM NO. <b>88898</b>	SIZE <b>A</b>	DRAWING NO. <b>7417-9129</b>	REV. <b>A</b>
SCALE	DO NOT SCALE PRINT	SHEET 7 of 78	

PSBR-01212 PSBR PDMP

TBD RBSP Mission Archive Plan

7417-9006 RBSP Configuration Management Plan

FSCM NO. <b>88898</b>	SIZE <b>A</b>	DRAWING NO. <b>7417-9129</b>	REV. <b>A</b>
SCALE	DO NOT SCALE PRINT	SHEET 8 of 78	



## 2 RBSP PROJECT OVERVIEW

### 2.1 PAYLOAD AND MISSION

The fundamental processes that energize, transport, and cause the loss of charged particles operate throughout the plasma universe at locations as diverse as magnetized and un-magnetized planets, the solar wind, our Sun, and other stars. The same processes operate within our immediate environment, the inner magnetosphere – Earth’s natural particle accelerator. The Living With a Star (LWS) program’s RBSP mission will provide the in situ observations needed to obtain a comprehensive understanding of these fundamental processes. The two-year RBSP mission offers local time, altitude, and geomagnetic activity coverage sufficient to sample a wide range of energetic particle events, to identify the underlying physical processes, and to determine their relative significances and interaction modes. In addition, the mission will quantify the time-varying structure and processes of the inner magnetosphere, identify source populations, and determine when and where relevant plasma waves are generated. The knowledge gained from the RBSP mission will aid in developing both empirical and predictive models that can be used to safeguard astronauts and spacecraft in near-Earth orbit and future exploration missions to Mars and the other planets.

Discriminating between proposed interaction mechanisms, distinguishing between energetic charged particle source and loss regions, and determining the spatial extent of the various phenomena manifested in the radiation belts requires simultaneous observations over a wide range of spacecraft separations. To accomplish this task, the RBSP mission will operate two Earth-orbiting spacecraft in near-equatorial, eccentric orbits with somewhat different apogees and orbital periods to provide a variety of radial and local time separations between the spacecraft over the course of the mission. The orbits of the spacecraft will be near equatorial to observe full particle pitch angle distributions with respect to the magnetic field within the radiation belts and to observe processes that are confined to regions near the magnetic equator. The instruments will make charged particle observations over energies ranging from those of the source population (as low as 1 eV) to those representative of the most energetic particles within the radiation belts (1 GeV). To distinguish between source populations, identify the predominant contributors to the ring current, and understand wave-particle interaction modes the instruments will obtain ion composition measurements over energies ranging from 1 eV to 1000 keV. To understand the transport and energization of relativistic particles within the inner magnetosphere, the instruments will obtain observations of the slowly evolving DC electric and magnetic fields. To identify wave-particle interaction modes that lead to both particle acceleration and loss, the instruments will obtain observations of 3D wave electric and magnetic fields over the full range of frequencies capable of interacting with particles (nominally, 10 Hz to 12 kHz for the Earth’s inner magnetosphere). Finally, plasma densities governing the structure of the inner magnetosphere are best determined from combined observations of low energy (<1 keV) ions, the spacecraft potential, and plasma wave resonances to 400 kHz.

In order to achieve the above mission science, the RBSP payload includes the following science investigations:

FSCM NO. <b>88898</b>	SIZE <b>A</b>	DRAWING NO. <b>7417-9129</b>	REV. <b>A</b>
SCALE	DO NOT SCALE PRINT	SHEET 9 of 78	

1. The Energetic Particle, Composition and Thermal Plasma Suite (ECT). This investigation will determine the spatial, temporal, and pitch angle distributions of electrons and ions over a broad and continuous range of energies. It is designed to differentiate the causes of particle acceleration mechanisms, understand the production of plasma waves, determine how the inner magnetospheric plasma environment controls particle acceleration and loss, and characterize source particle populations and their transport. The investigation will provide a complete complement of data analysis techniques, case studies, theory, and modeling, along with expertise to define particle acceleration mechanisms, radiation belt particle enhancement and loss, and determine how the near-Earth environment controls those acceleration and loss processes.
2. The Electric and Magnetic Field Instrument Suite and Integrated Science (EMFISIS). This investigation will provide the observations needed to determine the origin of important plasma wave classes and their role in particle acceleration and loss processes. The investigation will also quantify the evolution of the magnetic field that defines the basic coordinate system controlling the structure of the radiation belts and the storm-time ring current. EMFISIS will provide calculations of on board spectra, including spectral matrices, making it possible to determine wave normal angles and Poynting fluxes for the plasma waves of interest and providing information for wave mode identification and propagation modeling which are essential for understanding and modeling of radiation particle physics. EMFISIS will also measure the upper hybrid frequency, permitting accurate determination of the electron plasma density required for analysis of wave propagation and instability growth rates.
3. The Electric Field and Waves (EFW) Instrument. The investigation will provide the observations needed to understand the electric field properties associated with particle energization, scattering and transport, and the role of the large-scale convection electric field in modifying the structure of the inner magnetosphere. EFW measurements of the spacecraft potential will be used to infer the ambient plasma density.
4. The Radiation Belt Storm Probes Ion Composition Experiment (RBSPICE). This investigation will provide observations that accurately resolve the ring current pressure distribution needed to understand how the inner magnetosphere changes during geomagnetic storms and how that storm environment supplies and supports the acceleration and loss processes involved in creating and sustaining hazardous radiation particle populations.
5. The Proton Spectrometer Belt Research (PSBR). This investigation will determine the upper range of proton fluxes in the inner magnetosphere and develop and validate models of the Van Allen radiation belts.

FSCM NO. <b>88898</b>	SIZE <b>A</b>	DRAWING NO. <b>7417-9129</b>	REV. <b>A</b>
SCALE	DO NOT SCALE PRINT	SHEET 10 of 78	

## 2.2 MISSION-LEVEL SCIENCE AND DATA OPERATIONS

The RBSP Mission will fully support the broader goals of the Heliophysics data environment by providing full and open access to various levels of the RBSP data products. During Phase C/D, the Science Working Group (SWG) has discussed coordination, cross calibration, and collaboration with other assets and missions and developed a framework for sharing data. A number of committees have been formed to plan mission operations; these include committees to coordinate with other space and ground based assets, a committee to discuss common magnetic coordinate systems to be used by the mission and a committee to plan burst mode operations

### 2.2.1 COORDINATION OF SCIENCE/DATA ACTIVITIES

The RBSP project will support the broader Heliophysics goals as laid out in the NASA Heliophysics Science Data Management Policy, which is a step forward in the evolution of the Heliophysics Data Environment. The goal of the Heliophysics Data Environment is to enable science discovery where data are efficiently served through Virtual Observatories (VOs) from distributed, active and (longer-term) resident archives. The RBSP instrument teams have agreed to work with the VOs, primarily the Virtual Radiation Belt Observatory (ViRBO, <http://www.virbo.org>), to promote the distribution of their data. VirBO with the assistance of the instrument teams will develop Space Physics Active Search and Extract (SPASE) meta-data that will be used to describe and catalog the RBSP mission data.

The RBSP mission has also partnered with the Space Physics Data Facility (SPDF) to make data available through the Coordinated Data Analysis Web site (CDAWeb).

In addition to working with the ViRBO and SPDF, the RBSP mission will also provide a Science Gateway – a web-based interface providing a common point of entry of specific interest to RBSP scientists as well as the general public. The RBSP Science Gateway will provide links to the individual RBSP SOC web site, common summary plots, planning tools such as an orbit plotter, RBSP space weather data, and RBSP ephemeris.

### 2.2.2 RBSP MISSION RULES OF THE ROAD FOR DATA USAGE

As part of the development of collaboration with the broader Heliophysics community, the mission has drafted a “Rules of the Road” to govern how RBSP instrument data is used.

1. The PI shall make all scientific data products available to the public, as stated in the RBSP Science Data Management Plan.
2. Users should consult with the PI to discuss the appropriate use of instrument data or model results and to ensure that the Users are accessing the most recent available versions of the data and analysis routines. Instrument team SOCs and/or VOs should facilitate this process, serving as the contact point between PI and users in most cases.
3. Users should heed the caveats of investigators to the interpretation and limitations of data or model results. Investigators supplying data or models may insist that such caveats be

FSCM NO. <b>88898</b>	SIZE <b>A</b>	DRAWING NO. <b>7417-9129</b>	REV. <b>A</b>
SCALE	DO NOT SCALE PRINT	SHEET 11 of 78	

published. Data and model version numbers should also be specified.

4. Browse products are not intended for science analysis or publication and should not be used for those purposes without consent of the PI.
5. Users should acknowledge the sources of data used in all publications, presentations, and reports.

*" We acknowledge the NASA Radiation Belt Storm Probes Mission and [PI name] for use of data."(list of PIs)*

6. Users are encouraged to provide the PI a copy of each manuscript that uses the PI's data prior to submission of that manuscript for consideration of publication. On publication the citation should be transmitted to the PI and any other providers of data.

### **2.2.3 COORDINATION OF SCIENCE/DATA ACTIVITIES BETWEEN RBSP TEAMS AND OTHER HELIOPHYSICS MISSIONS**

Through discussions of the SWG, the RBSP Mission has formed a number of committees that are responsible for coordination:

1. A working group concerned with coordination with ground based assets such as SuperDARN.
2. A working group concerned with coordination with other missions such as THEMIS.
3. A working group that coordinates with the RBSP partner mission BARREL
4. A working group to coordinate burst mode operations between EFW and EMFISIS
5. A magnetic model and coordinates working group with responsibility for defining an agreed set of magnetic field models and associated magnetic coordinate systems that will be used by the mission.

These committees hold regular teleconferences to facilitate planning and report to the SWG. The SWG holds bi-weekly teleconferences and regular face-to-face meetings during the year. In addition, RBSP has introduced a one-day data workshop to discuss working with RBSP data.

#### **2.2.3.1 DATA SHARING**

All of the teams will share their Level 1 through 4 products (as described in section 4) for use in data analysis. Each instrument team requires the calibrated magnetometer data from EMFISIS (as outlines in the Mission Requirements Document (MRD) and Science Team Allocated Requirements Document (STARD) to compute pitch angles (for the particle instruments) and to de-spin the field data. The particle instruments will also share data from overlapping instruments in order to verify particle fluxes in their detectors.

There are a number of additional data products, which will be made available to the various teams for specific uses. For example, the EFW and EMFISIS teams share hardware and therefore they will share information on modes on both axial and spin-plane booms including the

FSCM NO. <b>88898</b>	SIZE <b>A</b>	DRAWING NO. <b>7417-9129</b>	REV. <b>A</b>
SCALE	DO NOT SCALE PRINT	SHEET	12 of 78

operational mode and when calibrations across frequency occur

EFW has a large on-board burst buffer and can prioritize the down-linking of these data by reviewing data products from other teams in addition to their own survey data. The EFW team can prioritize the selection of burst data for downlink using EFW data only, but their science can be greatly enhanced if the data listed below from other instruments are available within one week of acquisition. However the receipt of the additional data products is a goal and not a requirement. Examples of these products include:

From EMFISIS - Magnetic field vector in inertial coordinate system; Frequency vs. time spectrograms showing spectral density of electric and magnetic field fluctuations, covering frequencies up to 400 kHz; Magnetic Search Coil (MSC) response up to 12 kHz; wave power (plasma line, hiss, chorus, AKR); Start time, duration, and EMFISIS configuration for burst intervals.

From ECT/HOPE – estimates of plasma density.

From ECT and RBSPICE – ion/electron time spectrograms and line plots versus time (or L-value) from representative energy and pitch angles to indicate intervals of injection or perpendicular or parallel acceleration.

In addition to the payload data from RBSP, the mission will also collaborate with other missions to augment primary data sets. One such mission is BARREL (Balloon Array for RBSP Relativistic Electron Losses), a multiple-balloon experiment designed to study relativistic electron precipitation. The BARREL mission will provide in near real-time (within 1 hour) the balloon locations, times of conjunctions with RBSP, and summary plots (e.g. count rates, raw spectra). The mission will also provide final data products including flux and energy spectrum of precipitating electrons for specific events, and maps of spatial distribution of precipitation. In order to validate and improve the instrument response, the BARREL mission will require from RBSP, electron fluxes at view directions near and/or within the loss cone for specific events. The EFW team will also use the BARREL flight times as criteria for prioritizing the down link of their burst data.

Through working groups the RBSP project team will also collaborate with existing missions such as THEMIS and with ground based facilities such as the SuperDARN radar network.

### 2.2.3.2 OPERATIONS PLANNING

While observations from other Heliophysics missions are not required to achieve RBSP Level 1 science objectives, it is advantageous to be able to augment the science by using data from other missions. In particular, it is important for instrument teams to be able to find conjunctions between RBSP and other suitable missions so that burst mode operations can be planned.

FSCM NO. <b>88898</b>	SIZE <b>A</b>	DRAWING NO. <b>7417-9129</b>	REV. <b>A</b>
SCALE	DO NOT SCALE PRINT	SHEET 13 of 78	

In this context, “conjunction” is used to denote a time when the relative locations of RBSP and another mission are scientifically interesting. This could be a spatial location (i.e. the spacecraft are located on the same magnetic field line), or a temporal location such that one mission is located in a source region while the other is in the target region while studying the same temporal event.

The Science Gateway (described above in 2.2.1) will be used to make the RBSP predicted ephemeris available in order that other missions can calculate conjunction times. The mission will also routinely produce an operations list containing conjunctions with satellites of particular interest to the RBSP mission. Some examples of such missions include:

#### DSX (Demonstration and Science Experiments) Satellite

There are a number of conditions which are of mutual interest to both the RBSP and DSX missions, including: when both satellites are on the same side of the planet (for point-to-point VLF transmission measurements), when both satellites are in the same drift shell +/- 500 km, when both satellites are on the same magnetic field line  $\pm$  500 km, and when both satellites are within ~ 500 – 600 km of each other. DSX and RBSP ephemeris will be computed to determine nominal conjunction opportunities prior to launch so as to give insight into frequency of occurrence for each type of conjunction. The real conjunction opportunities will be determined post launch, and the data will be used to validate and develop radiation belt models.

#### BARREL

It is highly desirable for the BARREL mission to be able to launch the balloons when the RBSP satellites are in prime locations. In order to identify and predict conjunctions with the BARREL mission, the predicted location of the balloons will be mapped to the equator for comparison with the RBSP ephemeris data.

#### GPS and Geosynchronous Satellites

Conjunctions between the RBSP spacecraft and LANL/GPS and LANL/GEO are scientifically interesting but no special operations for RBSP are deemed necessary at this time. There are a large number (<24) of GPS satellites with LANL particle sensors, therefore, GPS conjunctions will be frequent and will occur at a range of L-shells.

Geosynchronous conjunctions will only occur when the RBSP spacecraft are off the geographic equator and therefore also separated by latitude. Geosynchronous orbit will be used mainly to set boundary conditions for event studies and global models. When the RBSP spacecraft are at apogee and moving slowly, conjunctions will last a long time. These conjunctions will happen seasonally when the RBSP spacecraft are at their highest inclination. It is not anticipated that any special operations would be scheduled during the first season of conjunctions, but based on

FSCM NO. <b>88898</b>	SIZE <b>A</b>	DRAWING NO. <b>7417-9129</b>	REV. <b>A</b>
SCALE	DO NOT SCALE PRINT	SHEET 14 of 78	

investigations of burst data during that season, it is possible that the mission will plan to collect some special burst mode data during the next conjunction season 6-months later.

#### HEO Satellites

Similar to the GPS and Geosynchronous satellites above, there will be many occasions when the RBSP and HEO spacecraft are in conjunction, but no special operations will be planned.

#### THEMIS

The 3 innermost THEMIS spacecraft will be in the center of the magnetotail in June 2012 with apogees of 11.5, 11.6, and 11.7  $R_E$  and RBSP will be at dawn at this time. THEMIS will be in the tail again in July 2013 when RBSP is located in the dusk sector and again in August 2014 when RBSP is back in the dawn sector. Data from THEMIS during these times will provide good coverage of the nightside sector to augment the RBSP data. Both RBSP and THEMIS line of apsides will be at local noon around December 2013, allowing for THEMIS to provide solar wind data just sunward of the magnetopause while RBSP samples the critical dayside radiation belt region. This collaborative study will of course depend on continued extended funding for the THEMIS mission

FSCM NO. <b>88898</b>	SIZE <b>A</b>	DRAWING NO. <b>7417-9129</b>	REV. <b>A</b>
SCALE	DO NOT SCALE PRINT	SHEET 15 of 78	

## 3 DATA PROCESSING

### 3.1 APPROACH

The RBSP ground system is comprised of a centralized Mission Operation Center (MOC) and one Science Operation Center (SOC) per instrument suite. The SOC's instrument operations are decoupled from the spacecraft operations and operate independently from each other. Spacecraft telemetry is distributed from the MOC to each of the instrument suite SOC's by three different methods as stated in the MOC-SOC ICD (7417-9050):

1. Real-time telemetry

During spacecraft ground contacts, real-time telemetry will be made available over a secure TCP/IP data stream.

2. Telemetry Playback

After downlink, the telemetry received by the MOC will be made available within 8 hours through playback using a secure TCP/IP data stream.

3. Level zero telemetry files

The MOC will maintain an archive of daily level zero telemetry files available through sFTP. On a daily basis, these files will be generated from the archived spacecraft and instrument data. The level zero files contain "cleaned and merged" spacecraft telemetry with corrupt and duplicate packets removed.

The MOC will also make available spacecraft attitude and ancillary data available to the instrument suite SOC's as described in the MOC Data Product Document (7417-9105).

The SOC's will pull the level zero and ancillary data from the MOC and generate their quick-look and higher level data products within the timeframe specified in the Mission Requirements Document (MRD 7417-9013) and Science Team Allocated Requirements Document (7417-9148).

FSCM NO. <b>88898</b>	SIZE <b>A</b>	DRAWING NO. <b>7417-9129</b>	REV. <b>A</b>
SCALE	DO NOT SCALE PRINT	SHEET 16 of 78	



## 3.2 IMPLEMENTATION

### 3.2.1 ECT

The ECT suite SOC consists of two components:

- The ECT Command, Telemetry, and GSE (CTG) component, which is primarily responsible for the command interface to the MOC, retrieving science and ancillary data from the MOC, providing basic State of Health (SOH) monitoring through quick look data and SOH products, and for providing L0 files (raw, time-tagged instrument specific telemetry data from MOC) to the ECT SDC.
- The ECT Science Data Center (SDC) component, which is responsible for the production and dissemination of all higher-level ECT data products and ancillary data. Level 1 to Level 4 data products are computed here, and the ECT-SDC website is maintained for summary plot dissemination and data access.

Level 4 data and ancillary data products exceed the mission requirements and will be generated on an as needed or requested basis and made publically available.

FSCM NO. <b>88898</b>	SIZE <b>A</b>	DRAWING NO. <b>7417-9129</b>	REV. <b>A</b>
SCALE	DO NOT SCALE PRINT	SHEET 17 of 78	

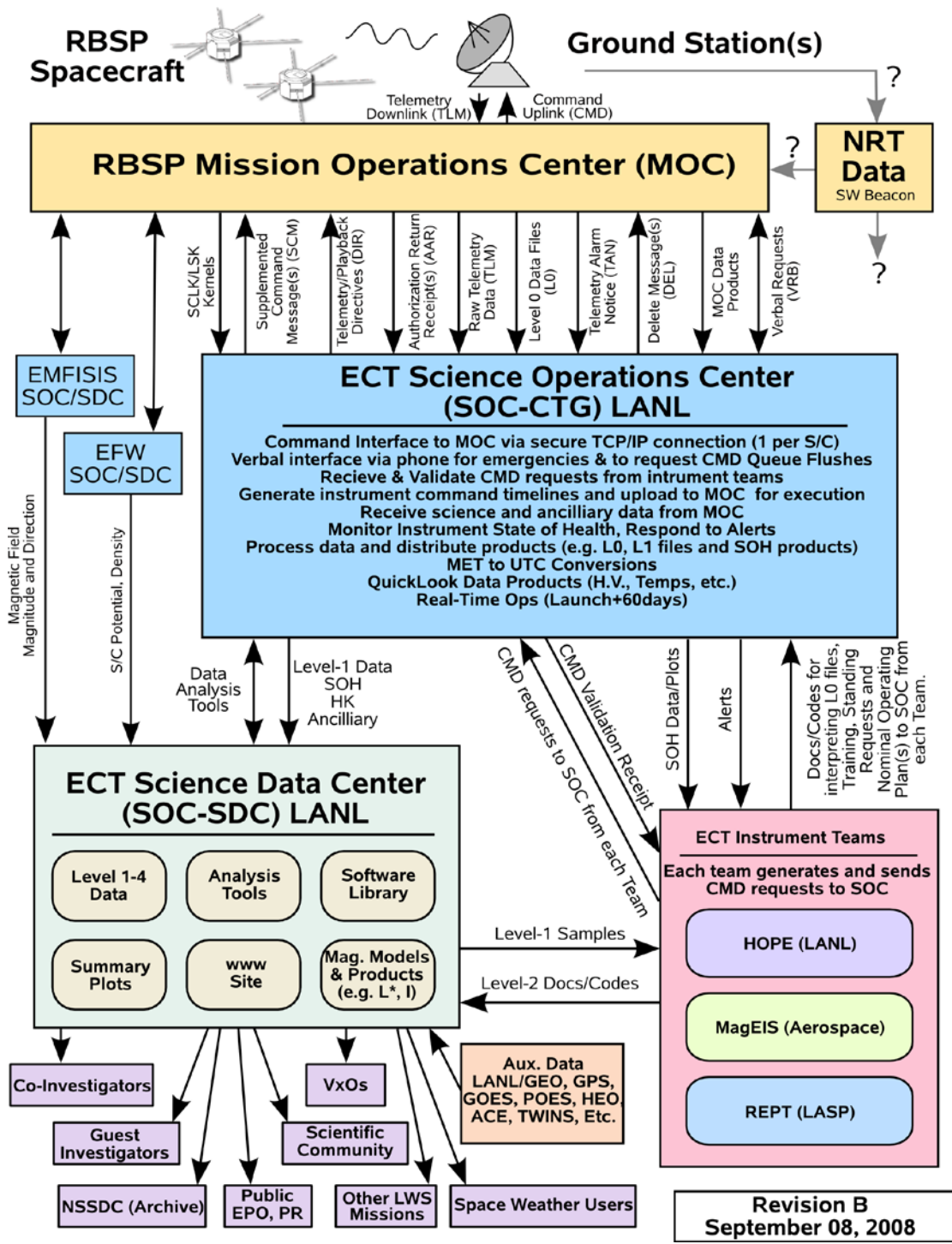

Figure 3.2.1.a Overall flow chart of the ECT SOC-GTG and SOC-SDC

FSCM NO. <b>88898</b>	SIZE <b>A</b>	DRAWING NO. <b>7417-9129</b>	REV. <b>A</b>
SCALE	DO NOT SCALE PRINT		SHEET 18 of 78

### 3.2.1.1 ECT COMMANDING AND HEALTH AND SAFETY OPERATIONS VIA SOC-CTG

The ECT SOC-CTG will be based on the Ground Support Equipment Operating System (GSEOS) running on PC-based Linux workstations at LANL and on PC-based laptops for the portable SOC. The same system will be used for the test SOC to support Integration and Test (I&T) activities. All ECT instruments teams (MagEIS, REPT and HOPE) have agreed to use the GSEOS for their instrument-specific implementation of their Ground Support Equipment (GSE). The ECT Command SOC will utilize appropriate subsets of the three instrument GSE systems at the SOC and provide the communications layer to the MOC as required by the MOC-SOC ICD. As much of the instrument-specific displays and command structure as possible will be adopted into the SOC to provide each instrument team with an output/interface that they are familiar with.

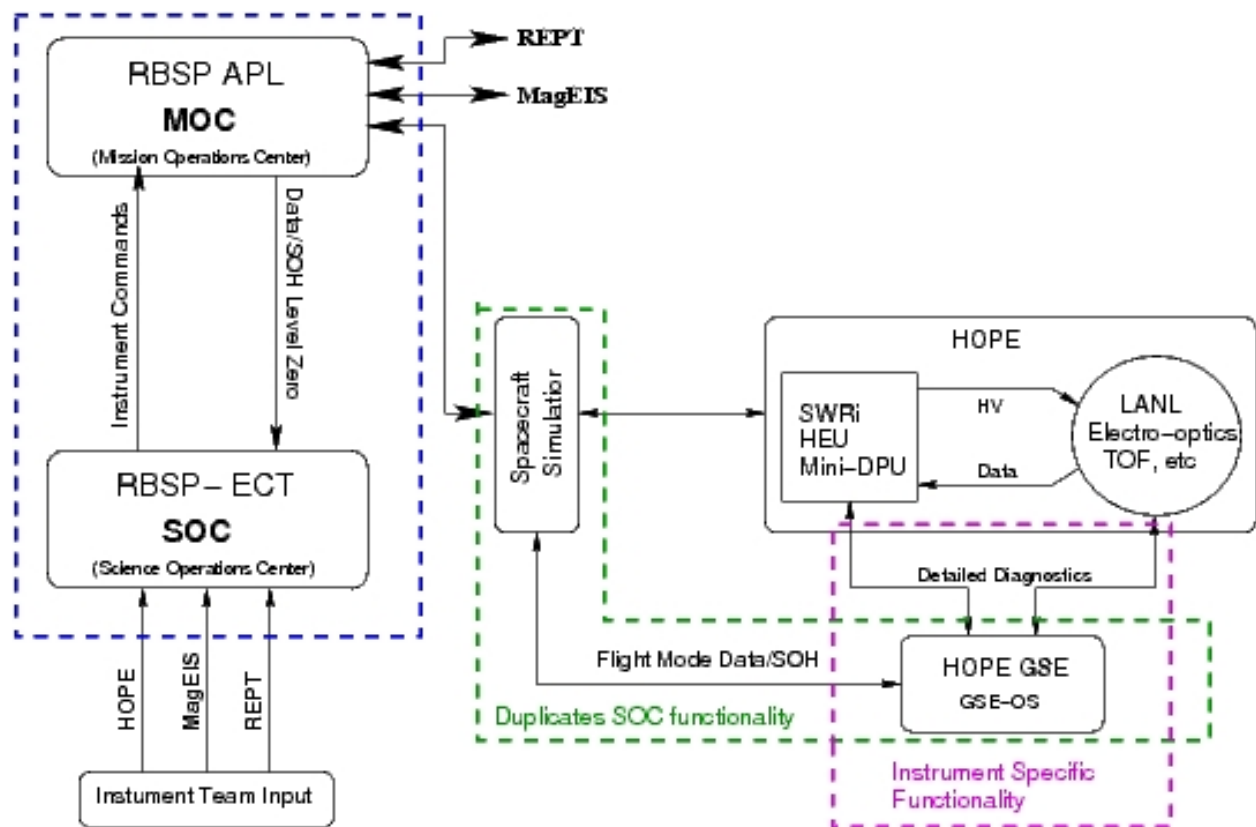

Figure 3.2.1.b Overall implementation of the ECT SOC-CTG.

Figure 3.2.1.b shows the overall implementation of the ECT CTG. The areas outlined in purple represent instrument specific interfaces to the GSE that will not be replicated in the ECT CTG. The areas outlined in green represent functionality that will be incorporated into the ECT CTG.

FSCM NO. <b>88898</b>	SIZE <b>A</b>	DRAWING NO. <b>7417-9129</b>	REV. <b>A</b>
SCALE	DO NOT SCALE PRINT	SHEET 19 of 78	

The SOC specific functionality will be to “package up” the individual instrument command sequences according to the required MOC format and to send them to the MOC. The command and telemetry interfaces will be implemented using the Ground Support Equipment Operating System (GSEOS) software. A customized version of GSEOS was developed with funds from APL and LANL to implement the MOC to SOC interfaces allowing the software, which was already used as par of the GSEO for instrument development be reused for operations. The SOC will implement instrument-specific checks to ensure that the commands are valid, and perform checks to ensure safe transmission of the commands to the MOC. It is intended to use an email/ftp-site clear text protocol for each of the ECT instrument teams (HOPE, MagEIS and REPT), where the teams can send command requests and provide web/ftp-based feedback on the status of their command queue. It is envisaged that routine command operations can be performed autonomously by the SOC.

SOC feedback during commissioning at APL will be provided through a remote terminal monitoring utility such as Virtual Network Connection (VNC) implemented over a Secure Shell (SSH) tunnel, or by directly sharing GSEOS screens. Instrument teams will be able to view the SOC GSEOS session in real time, and if required, will be able to issue commands or request specific diagnostic output. During normal operations, the SOC output will be provided through a password-protected site as part of the ECT-SOC web server. This will take the form of frequently updated screenshots of the various GSEOS diagnostic pages as defined by the ECT instrument teams.

A standard set of diagnostic products for instrument monitoring will be produced by the SOC based on State of Health (SOH) and Level 0 data. These plots will be available within minutes of the receipt of data and will be provided through the ECT SDC website from a team-specific, password protected area.

### 3.2.1.2 ECT DATA PROCESSING, ARCHIVING AND DISSEMINATION VIA ECT-SDC

The ECT Science Data Center, in collaboration with the individual instrument teams, is responsible for all data processing and dissemination of level 1 data products and above. The ECT SDC will be implemented on PC-based Linux systems that are available at Los Alamos, making available the full set of computing resources (mass storage, NetAps disk storage, LANL firewall security, ancillary data) to the ECT-SDC.

All data levels available to the public (level 2 and above) will be provided in the CDF format outlined by the COSPAR Panel on Radiation Belt Monitoring (PRBEM) which is a CDF format based on the ISTEP standard but specifically tailored for particle data. Many of the ancillary data products that will be made available through the SDC are already in this format (LANL GEO, GPS, NOAA Tiros, etc). Information on the PRBEM CDF format can be found at the following website: [http://craterre.onecert.fr//prbem/Reference\\_documents.html](http://craterre.onecert.fr//prbem/Reference_documents.html).

FSCM NO. <b>88898</b>	SIZE <b>A</b>	DRAWING NO. <b>7417-9129</b>	REV. <b>A</b>
SCALE	DO NOT SCALE PRINT	SHEET 20 of 78	

Data will be made available through the ECT-SDC website either in the form of digital data or data plots. The same website will be used to make available ancillary data from other concurrent missions / data sources.

The ECT-SDC website will function mainly as a gateway to the JAVA-based autoplot utility (<http://autoplot.org/>) that will function as the user's main interface to ECT data. Autoplot provides for a summary plot-browser for pre-computed plots and a fully featured renderer for space-instrument data that can be used to display ECT or ancillary data, or any combination thereof.

ECT will use ancillary magnetic field data from the EMFISIS SOC to derive pitch-angle resolved data products. To safeguard against unavailability or unacceptable latency in the magnetic field data, an initial computation of the magnetic field direction based on the symmetries of the high energy (>50keV) particle distributions will be used to calculate pitch angles to a coarser fidelity. These data products will be recalculated as soon as higher fidelity magnetic field data becomes available.

The data products provided by ECT will range from simple calibrated fluxes per energy channel to higher-level derived science products (pitch angles, moments) and products dependent on global magnetic field models (phase space densities in magnetic coordinates). See Section 4.1.1 for details.

Quality control is an important aspect of the ECT-SDC operation and it is intended to maintain two levels of access to the data; one is internal to the ECT team, and the other is available to the general public. For each instrument and each level of processing a set of identified diagnostic plots will be "validated" by a designated individual prior to the public release of that data, nominally within 2 months of ground receipt, as dictated by the Mission requirements Document (MRD).

This validation will be done for each data level in turn; L1 data has to be released before L2 products are produced, and so on. This process will be accomplished via a "click-and-release" mechanism in the team-specific password protected area of the ECT-SDC website. This quality-control step will most likely be intensive during the initial start-up operation of the SDC but it may be bypassed or replaced by a rule-based system once normal operations have been established.

Technical support for the end user (outside of the ECT team) will mainly be through the data file format itself – the CDF format is self-descriptive, and will include information on any caveats on the data and on the processing history of the data files. While it is impossible to check on "correct use of the data" by the end user, users will be encouraged to check the use of the data against the standard data plots available for each data level on the ECT-SDC website. Each data file will further contain a disclaimer that the end user is encouraged to contact a member of the

FSCM NO. <b>88898</b>	SIZE <b>A</b>	DRAWING NO. <b>7417-9129</b>	REV. <b>A</b>
SCALE	DO NOT SCALE PRINT	SHEET 21 of 78	

ECT instrument team to ensure proper use and interpretation of the ECT data prior to publication.

### 3.2.2 EFW

The EFW Science Operation Center (SOC) consists of two components:

- The EFW SOC Command, Telemetry, and GSE (CTG) component, which is primarily responsible for providing the EFW command interface to the MOC, monitoring basic instrument state-of-health (SOH) through the production of quick-look and trended SOH products, as well as supporting the EFW GSE interface during instrument and spacecraft integration and test (I&T).
- The EFW Science Data Center (SDC) component, which is responsible for fetching EFW L0 data from the RBSP MOC, and the production and dissemination of all higher level (L1 through L4) EFW data products and ancillary data. L1 to L4 data products are computed by this collection of modules, archived, and served to any external sites as required.

FSCM NO. <b>88898</b>	SIZE <b>A</b>	DRAWING NO. <b>7417-9129</b>	REV. <b>A</b>
SCALE	DO NOT SCALE PRINT	SHEET 22 of 78	

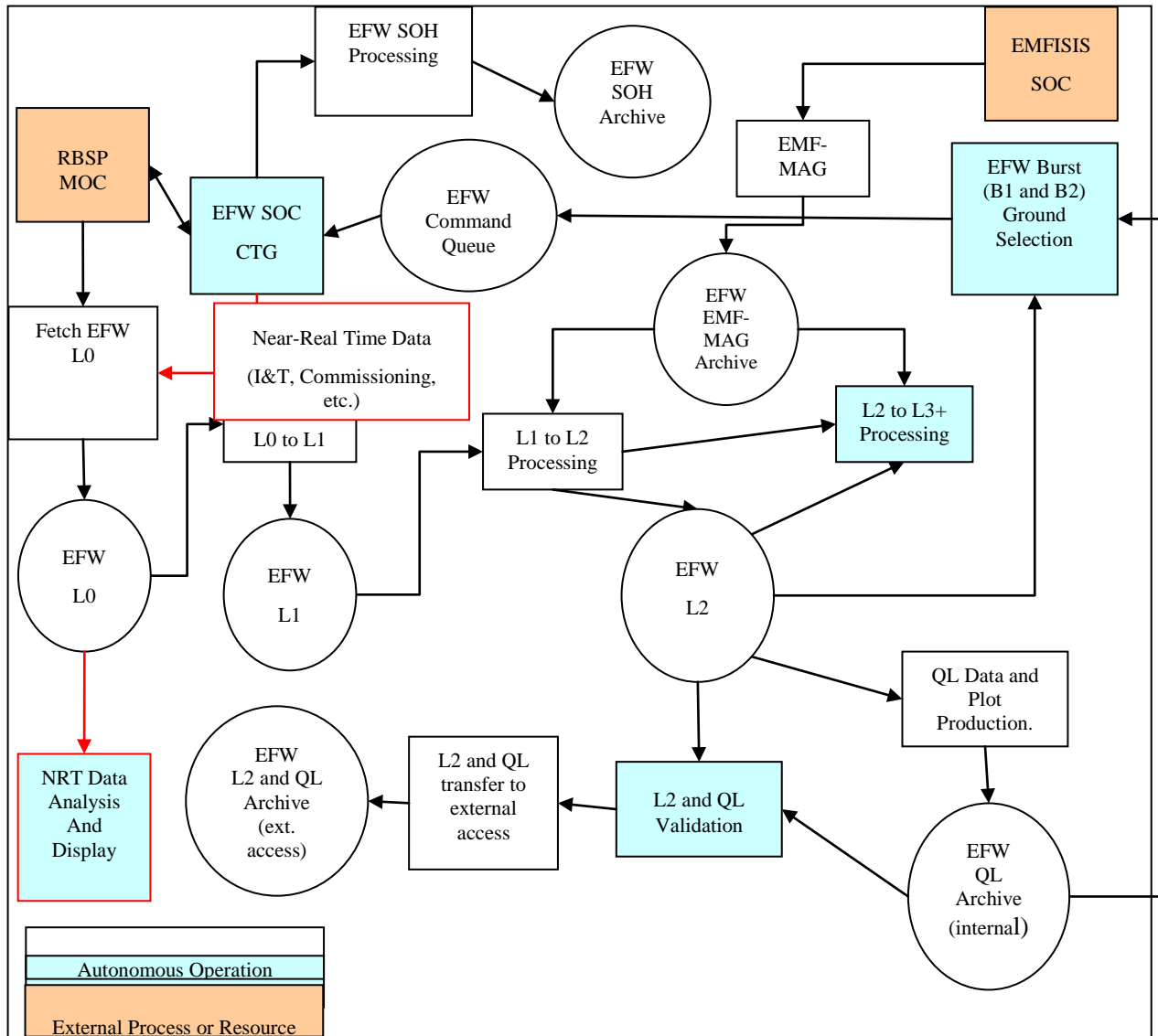

Figure 3.2.3.a Overall Flow Chart of EFW CTG and SDC

Note: The handling of near-real-time data, such as that produced during instrument and spacecraft integration and test, as well as on-orbit commissioning, flows through the initial modules of the normal stored telemetry processing stream (Fetch and Archive of L0).

### 3.2.2.1 EFW COMMANDING AND HEALTH AND SAFETY OPERATIONS VIA SOC-CTG

The EFW SOC-CTG will be based on the GSEOS system running on PC desktops at UC Berkeley Space Sciences Laboratory (UCB SSL) and on PC-based laptops for the portable SOC.

FSCM NO. <b>88898</b>	SIZE <b>A</b>	DRAWING NO. <b>7417-9129</b>	REV. <b>A</b>
SCALE	DO NOT SCALE PRINT	SHEET 23 of 78	

The EFW-CTG will provide the communications layer to and from the MOC as required by the MOC-SOC ICD.

The primary CTG-specific functionality will be to “package up” the EFW command sequences according to the required MOC format, to send those sequences to the MOC, as well as to receive near-real-time telemetry streams during Instrument and Spacecraft I&T and On-Orbit Commissioning operations. This communications layer will be implemented in GSEOS. The SOC will validate commands prior to transmission to the MOC, verify correct UTC to MET time conversion on all relevant commands, and perform checks to ensure safe transmission of the commands to the MOC. It is envisaged that routine command operations (burst selection commanding, for example) will be performed autonomously by the SOC soon after the Commissioning phase is complete.

CTG monitoring of telemetry and commanding of the EFW instrument during commissioning, will be provided through in-person staffing of the EFW SOC in an IT-secure location, either in the RBSP MOC, or at the EFW SOC at UCB. The EFW engineering, SOC, science teams will be able to view the CTG GSEOS session in real time, and, if required, issue commands or request specific diagnostic output. During normal operations, the CTG remote sessions (e.g. a VNC session) will run in read-only mode, with the GSEOS session displaying the standard state-of-health and data diagnostic displays as requested by the SOC and Science teams. EFW commanding will take place in the IT-secure EFW SOC location.

Scripted and on-demand production of state-of-health plots and data products are handled by a separate process based on instrument housekeeping in the L0 data stream. These data and plots will be available minutes from receipt of data and will be provided through the EFW SDC website.

### **3.2.2.2 EFW DATA PROCESSING, ARCHIVING AND DISSEMINATION VIA SOC-SDC**

The EFW SDC is responsible for all data processing and dissemination of level 1 data products and above. The EFW SDC will be implemented on PC-based Linux systems as part of the existing UCB SSL computing infrastructure (firewall security, automated backup, ancillary data access).

All data levels available to the public (level 2 and above) will be provided in the ISTEP-compliant CDF format with enhancements to the time tagging to allow access to the full temporal resolution of the waveform data collected by EFW, as well as full use of the THEMIS Data Analysis Software (TDAS) suite of data analysis routines.

Data will be made available through the EFW-SDC website either in the form of digital data (CDFs) or data plots. The same website will be used to make available ancillary data from other concurrent missions / data sources.

FSCM NO. <b>88898</b>	SIZE <b>A</b>	DRAWING NO. <b>7417-9129</b>	REV. <b>A</b>
SCALE	DO NOT SCALE PRINT	SHEET 24 of 78	



Several ancillary data products are required for the complete and accurate reduction and production of higher-level EFW data products (L2+). These are the precision ephemeris and attitude data from the RBSP observatories themselves, as well as the DC magnetic field data from the EMFISIS-MAG instrument. The ephemeris and attitude data are part of the standard MOC data products, and are archived locally at the EFW-SDC after acquisition by the EFW-CTG. The DC magnetic field data will be acquired from the EMFISIS-SOC/SDC and archived locally as well. These data will be used to produce EFW waveform data products in geophysically relevant coordinate systems, as well as in inertial or co-rotating references frames (i. e. removal of the spacecraft frame  $-V \times B$  E-field).

The EFW data products range from calibrated waveform data in spinning and de-spun coordinate systems, on-board and ground-processed spectral, cross-spectral, and interferometric estimates, through higher-level data products such as global estimates of the convection electric field. Here, it is important to distinguish between efforts covered by the EFW-SOC and those covered by the EFW Science team and their collaborators. As one proceeds to Higher level data products (L4), the burden of effort transfers from the SDC processing to actual analysis and research by the Science team, and while these higher level data products will be made available publicly, it will be as part of the natural research efforts of the EFW science team and their collaborators.

Essential to the production of the publicly available data products (L2+), is the concept of validation and verification by members of the EFW science team. Here, EFW will adopt a well-known and tested strategy (GEOTAIL, RHESSI, THEMIS), known variously as the TOHBAN (Duty Scientist; literally “duty officer” or “officer of the day”), where a single member of the EFW science team is designated TOHBAN for a given period of time (typically 1-2 week stints), and serves as the interface between the Science and SOC teams. The TOHBAN is required to maintain watch on data acquisition and quality, and will have the additional duty for RBSP-EFW of ground selection of certain kinds of burst waveform data.

Technical support for the end user (outside of the EFW team) will mainly be through the data file format itself – the CDF format is self-descriptive, and will include information on any caveats on the data and on the processing history of the data files. Each data file will contain a disclaimer that the end user is encouraged to contact a member of the EFW instrument team to ensure proper use and interpretation of the EFW data prior to publication.

### 3.2.3 EMFISIS

The EMFISIS Science Operation Center (SOC) consists of two components:

- The EMFISIS Command, Telemetry, and GSE (CTG) component, which is primarily responsible for the command interface to the MOC, providing all uploaded commands, software uploads, and other spacecraft operational functions.
- The EMFISIS Science Data Center (SDC) component, which is responsible for retrieving

FSCM NO. <b>88898</b>	SIZE <b>A</b>	DRAWING NO. <b>7417-9129</b>	REV. <b>A</b>
SCALE	DO NOT SCALE PRINT	SHEET 25 of 78	

science and ancillary data from the MOC, providing basic health and safety monitoring through housekeeping data checks, providing quick look data products, and for providing L0 files (raw, time-tagged instrument specific telemetry data from MOC) to the members of the EMFISIS team for further data processing to levels L1-L4. In addition, the EMFISIS SDC is responsible for the dissemination of all higher-level data EMFISIS products and ancillary data. Level 1 to L4 data products are computed here, and the EMFISIS SDC website is maintained for summary plot dissemination and data access.

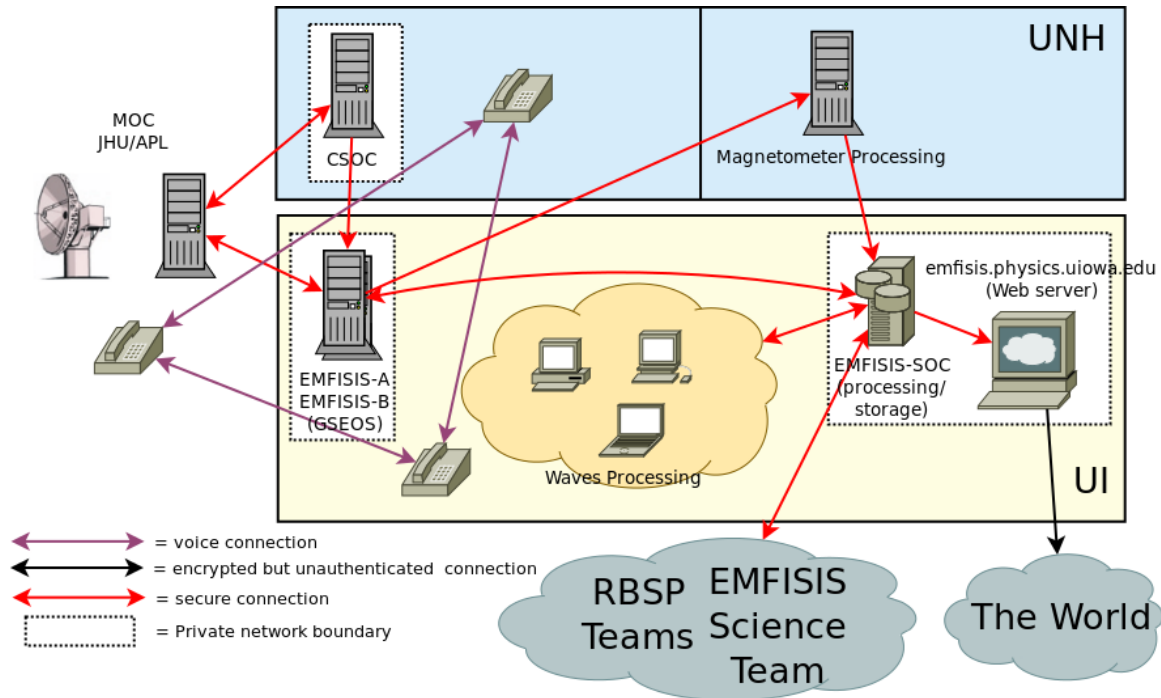

Figure 3.2.2.a Overall flow chart of the EMFISIS SOC

A block level diagram of the data flow from MOC to final data products is shown in Figure 3.2.2b and illustrates the path from Level 0 data products to higher level products to be made available to the public and scientific community.

FSCM NO. <b>88898</b>	SIZE <b>A</b>	DRAWING NO. <b>7417-9129</b>	REV. <b>A</b>
SCALE	DO NOT SCALE PRINT	SHEET 26 of 78	

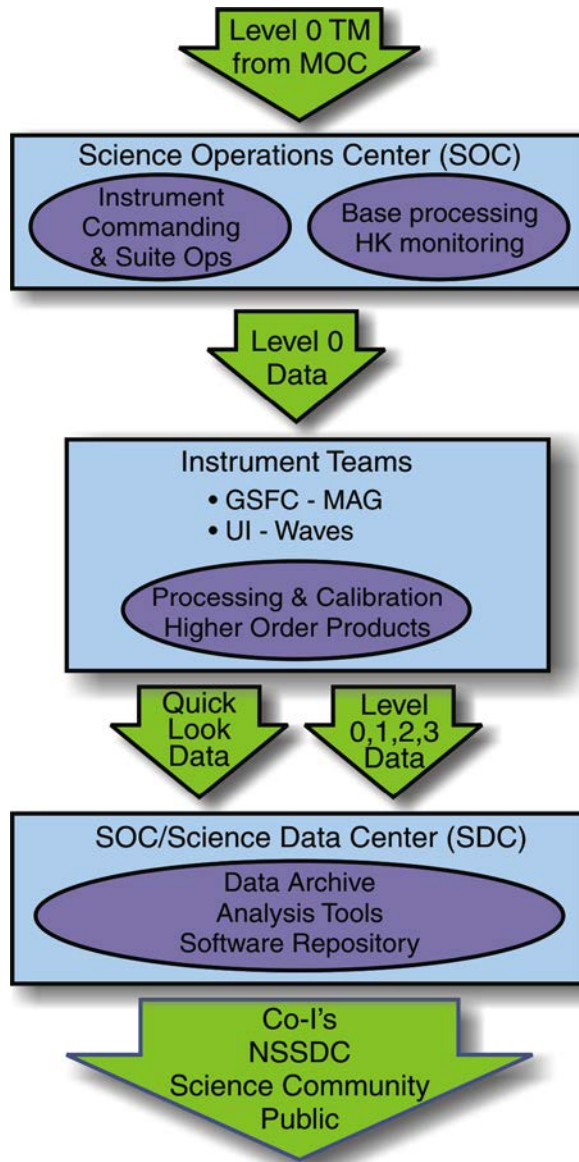

Figure 3.2.2.b EMFISIS Data flow

FSCM NO. <b>88898</b>	SIZE <b>A</b>	DRAWING NO. <b>7417-9129</b>	REV. <b>A</b>
SCALE	DO NOT SCALE PRINT		SHEET 27 of 78

### 3.2.3.1 EMFISIS COMMANDING AND HEALTH AND SAFETY OPERATIONS VIA SOC-CTG

The EMFISIS Command, Telemetry, and GSE (CTG) will be based on the GSEOS system running on PC-based Linux and Windows workstations at the University of New Hampshire (UNH). The same system will be used for the test SOC to support I&T activities. Because the entire set of EMFISIS instruments operates under the control of the common CDPU, this CTG is the only point of contact for commanding EMFISIS instruments and all instrument commands will be routed through it. The GSEOS based system will provide the communications layer to the MOC as required by the MOC-SOC ICD.

The SOC specific functionality will be to take inputs from the Waves and MAG instrument teams (as well as maintenance and reconfigurations of the CDPU) and then generate the appropriate command sequences, which will be sent to the MOC. This communications layer will be implemented in GSE OS. The SOC will ensure that the commands are valid by performing checks of all commands and command sequences on an engineering model on the ground to ensure safe commanding before transmission of the commands to the MOC. It is envisaged that routine command operations can be performed autonomously by the SOC when routine operations are established after commissioning.

SOC operations will be capable of being carried out remotely to support I&T and commissioning. The instrument teams will be able to view the SOC GSEOS session in real time, and if required, issue commands or request specific diagnostic output. During normal operations, the SOC remote GSEOS session will show the standard diagnostic displays as requested developed for each instrument and the CDPU. For emergency commanding / debugging operations this connection can be interactively set for a specific display or mode as needed.

### 3.2.3.2 EMFISIS DATA PROCESSING, ARCHIVING AND DISSEMINATION VIA SOC-SDC

The EMFISIS Science Data Center (SDC), in collaboration with the individual instrument teams, is responsible for data processing and all data dissemination of the level 1 data products and above. The EMFISIS SDC will be implemented on a variety of platforms, primarily PC-based Linux systems and other Unix-based workstations. These workstations will be supported by sufficient storage and Internet bandwidth to perform the required operations.

The primary point of contact for the SDC will be located at the University of Iowa which will collect level 0 files from the MOC and distribute them to the instrument teams for specific processing as illustrated in Figure 3.2.2b. Instrument teams will then process this data into higher-level products and quick-look data. These data will then be returned to the UI SDC for dissemination to the RBSP science teams, the space science community and the public.

FSCM NO. <b>88898</b>	SIZE <b>A</b>	DRAWING NO. <b>7417-9129</b>	REV. <b>A</b>
SCALE	DO NOT SCALE PRINT	SHEET 28 of 78	

All data levels available to the public (level 1 and above) will be provided in the CDF format. Many of the ancillary data products that will be used in science analysis for RBSP are already in this format (LANL GEO, GPS, NOAA TIROS, etc), so this provides a useful common format.

Data will be made available through the EMFISIS SDC website either in the form of digital data or data plots. The same website will be used to make available links to ancillary data from other concurrent missions / data sources.

The only ancillary data product required by the EMFISIS SDC is the spacecraft attitude and position data. This is used to place measured field components into useful geophysical coordinates.

The EMFISIS data products to be provided range from calibrated time series of magnetic field vectors and wave spectra, to more complex quantities such as spectra, spectral matrices, and wave normal components and wave properties such as ellipticity and polarization.

Once in nominal operational mode, data quality will be assured through a validation process whereby designated team members will check a standard set of parameters plotted in the same way for a set time interval (which may vary depending on the parameter being checked). This will ensure the quality of data before it is released to the public. During initial operations, while the team is still checking all the details and calibrations of instrument performance, validation will be carried out at a higher level by carefully checking quantities such as expected fields as compared with models (for MAG), cross calibrations of different axes (both MAG and Waves), detailed housekeeping information, and other parameters of instrument function. These checks will be done for each data level in turn; L1 data has to be released before L2 products are produced, and so on.

Technical support for the end user (outside of the EMFISIS team) will mainly be through example routines for reading data as well as the data file format itself – the CDF format is self-descriptive, and will include information on any caveats on the data and on the processing history of the data files. To promote appropriate usage of data (and understanding of instrument details), we will encourage collaboration with the EMFISIS science team (when feasible) and we will also encourage users to compare their use of the data against the standard data plots available for each data level on the EMFISIS SDC website. Users will also have available information on any data quality issues and will be informed that it is appropriate to acknowledge the instrument team when the data is used in papers and presentations.

A standard set of “quick look” products will be produced by the EMFISIS SDC such as simple time series of MAG data and simple spectral properties of Waves data.

These will be generated by each of the instrument teams and then transferred to the EMFISIS SDC where they will be made available to users.

FSCM NO. <b>88898</b>	SIZE <b>A</b>	DRAWING NO. <b>7417-9129</b>	REV. <b>A</b>
SCALE	DO NOT SCALE PRINT	SHEET 29 of 78	

### 3.2.4 RBSPICE

Due to the need to fulfill the high level of security requirements and the desire to utilize the experience of team members from past missions, the RBSPICE Science operation center (SOC) is broken into two separate parts.

- The RBSPICE SOC Command, Real-Time Telemetry, and GSE (CTG) component, which is primarily responsible for providing the RBSPICE command interface to the MOC and monitoring instrument health and safety using the real-time instrument telemetry.
- The RBSPICE Science Data Center module (SDC), which is responsible for fetching RBSPICE L0 data from the RBSP MOC, and the data processing, analysis, production, distribution, and archiving functions of the higher level data products.

### RBSPICE Science Data Operations

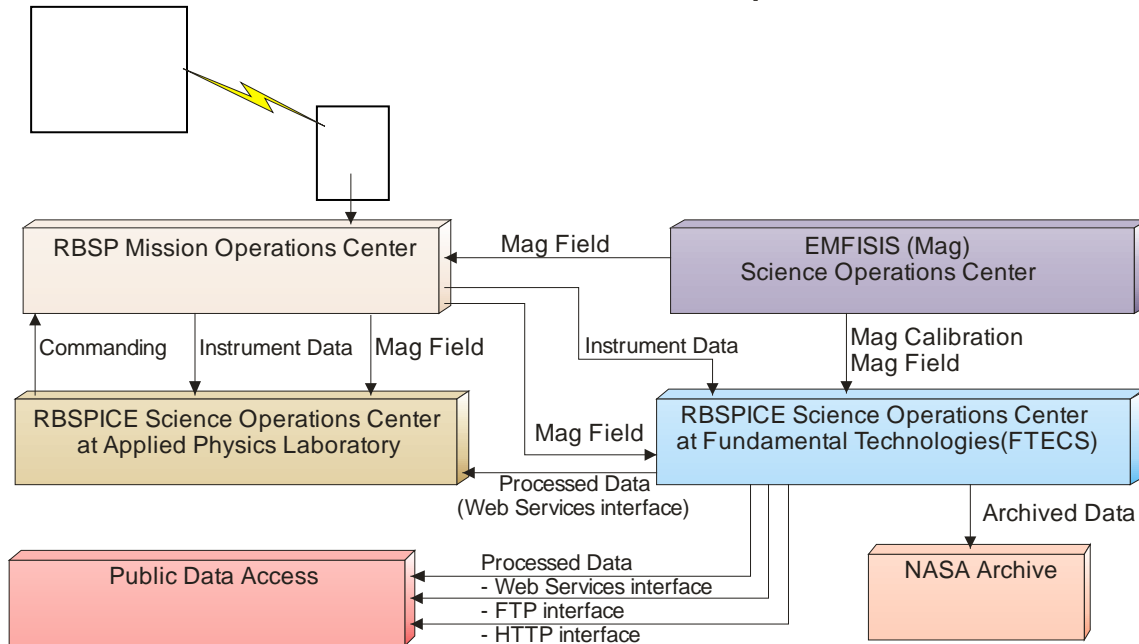

Figure 3.2.4.a Overview of the RBSPICE Science Operations Center Data Flow

FSCM NO. <b>88898</b>	SIZE <b>A</b>	DRAWING NO. <b>7417-9129</b>	REV. <b>A</b>
SCALE	DO NOT SCALE PRINT	SHEET 30 of 78	

The RBSPICE SOC is required to support the instrument payload and provide the tools and facilities needed to perform the Science Acquisition processes and Data Management and Archiving tasks associated with each instrument and its sensors. The SOC general requirements to provide this support have been defined in RBSP document 7423-9090 RBSPICE SOC Requirements document.

Figure 3.2.4.a above provides an overview of the RBSPICE SOC implementation and the flow of data from one RBSP processing environment to another.

It should be noted though that data analysis is a distributed function throughout the team with analysis software packages being developed as needed. One of the primary analysis packages is the Mission Independent Data Language (MIDL) software currently in production and maintenance at JHU/APL. RBSPICE data analysis functionality will be integrated into this package during Phase C/D and will be utilized for analysis and instrument monitoring during Phase E.

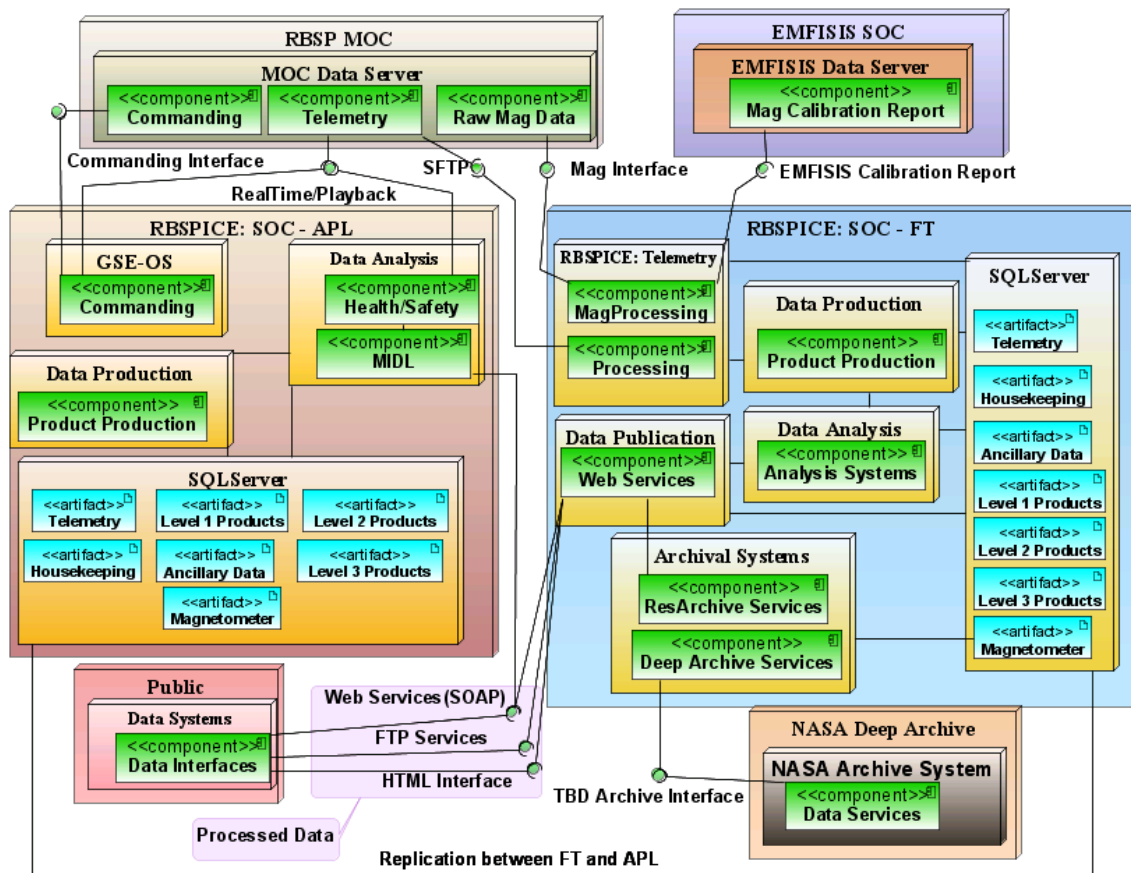

Figure 3.2.4.b RBSPICE SOC Deployment Diagram Overview

In Figure 3.2.4.b, a deployment diagram of the RBSP mission relevant to the RBSPICE SOC operations is shown describing the various nodes and components that are anticipated in the fully

FSCM NO. <b>88898</b>	SIZE <b>A</b>	DRAWING NO. <b>7417-9129</b>	REV. <b>A</b>
SCALE	DO NOT SCALE PRINT	SHEET 31 of 78	

operational RBSPICE SOC. This diagram identifies that the design of the RBSPICE SOC incorporates a reasonable amount of redundancy in capability between APL and FTECS. This is done to mitigate any risks to instrument data and SOC operations that might exist associated with equipment failure, network failure, and/or natural disasters. All data stored within the FTECS databases and file archives will be replicated at the APL facilities as well as some operational and processing capability. Two exceptions exist in regards to the level of redundancy, instrument commanding capability will exist only at APL for security reasons and data publication and archiving capability will exist only at FTECS.

As indicated in the diagram, FTECS will provide multiple interfaces for RBSP team and public retrieval of RBSPICE data products. The interfaces will be an enhancement of existing FTECS publication interfaces providing the capability for any particular data set, data product, or sub-section of data to be available for download through standard FTP and HTTP interfaces. In addition, the diagram also shows a proposed Web Services interface utilizing the Simple Object Access Protocol (SOAP) and XML wrappers of the RBSPICE data for transport. This interface will initially be tested and utilized between APL and FTECS and provide the means of moving analysis data products from FTECS to APL in a more natural form for computer processing. Final archiving to a NASA deep archive, such as NSSDC, will be done thru the published interfaces of the deep archive. In addition, Space Physics Archive Search and Extract (SPASE) compliant metadata will be produced and provided to whatever repository is identified by the RBSP project. The diagram does not directly display the SPASE interface since it is inherently part of the resident/deep archive process.

### **3.2.4.1 RBSPICE COMMANDING AND HEALTH AND SAFETY OPERATIONS VIA SOC-CTG**

The RBSPICE SOC-CTG will be based upon the GSEOS system running on a workstation at JHU/APL. This commanding workstation will provide the communications layer to the Mission Operations Center (MOC) and will be solely responsible for command generation, command validation, and command submission to the MOC. Command validation will be done against the RBSPICE Engineering Model (EM) and only those command sets that are vetted through the EM will be submitted for execution onboard either of the observatories. SOC feedback will occur thru the same workstation monitoring the real time telemetry and/or playback telemetry as needed especially during commissioning. Health and safety operations will be done via use of the telemetry display on the GSEOS workstation and thru additional analysis tools executing at JHU/APL.

### **3.2.4.2 RBSPICE DATA PROCESSING, ARCHIVING AND DISSEMINATION VIA SOC-SDC**

While the overall design of the RBSPICE SOC provides for redundant data processing capability at JHU/APL, normal data processing operations of the RBSPICE-SDC will occur at FTECS. In general, FTECS will receive the level 0 RBSPICE and EMFISIS MAG data from the MOC as well as the EMFISIS Calibration report from the EMFISIS SOC. Production of quick look and

FSCM NO. <b>88898</b>	SIZE <b>A</b>	DRAWING NO. <b>7417-9129</b>	REV. <b>A</b>
SCALE	DO NOT SCALE PRINT	SHEET 32 of 78	



higher level data products will be done in normal day to day operations with quick look data products being made available to the RBSP mission and general public immediately upon production. The release of initial versions of the RBSPICE higher level data products to the RBSP teams is expected to occur within a day of receipt of the required level 0 data. Public release of final fully vetted data products will be intentionally delayed according to the data products definition table 4.1 latency column since it is anticipated that there will be the need to produce multiple versions of each of the various data products based upon reception of corrected and filled level 0 data and magnetometer calibration data. After production, all data products will be archived into a database array at FTECS and then replicated to JHU/APL for redundancy and faster retrieval from JHU/APL science analysis tools.

Dissemination of all data products will occur at FTECS thru three different proposed interfaces. Quick look data and daily versions of each data product will be produced in both CDF and an ASCII comma separated file (CSV) version for FTP download by the RBSP teams and the general public. A web interface for the creation of smaller time targeted data sets will be created to allow for smaller data file and faster download times. A graphical display of a limited subset of RBSPICE data is also being considered for public non-publication use. Finally, a web services interface is being proposed to provide for access to the data from other computer systems for automatic processing and will provide a simple means of replication between FTECS and JHU/APL. This interface will package the data in SPASE compliant metadata descriptions and in XML data packages using a still to be specified data model.

The RBSPICE level 1 data products will include species specific count rates derived from the level 0 data as well as pitch angles derived from the RBSP mission provided SPICE kernels and the EMFISIS provided magnetometer data. Higher level data products will include pitch angle distributions (PAD's) per species per spin and PAD's per species averaged over a variety of spin periods for different sampling regions; particle flux; particle pressures; and phase space density (as available).

Technical support for the end user will occur via the generation of a variety of technical and user help files available at the FTECS web site. In general, these files will finally be combined into an RBSPICE Data Handbook similar to other documents produced by FTECS such as the Ulysses HiSCALE Data Analysis Handbook available for download from the FTECS Ulysses web site at HiScale.ftecs.com. While it is impossible to check on "correct use of the data" by the end user, the end user will be encourage to check the use of the data against the standard data plots available for each data level on the RBSPICE public website. Each data file will further contain a disclaimer that the end user is encouraged to contact a member of the RBSPICE instrument team to ensure proper use and interpretation of the RBSPICE data prior to publication (see Section 2.2.1.1 RBSP Mission Rules of the Road for Data Usage)

FSCM NO. <b>88898</b>	SIZE <b>A</b>	DRAWING NO. <b>7417-9129</b>	REV. <b>A</b>
SCALE	DO NOT SCALE PRINT	SHEET 33 of 78	

### 3.2.5 PSBR/RPS

The processing of the Relativistic Proton Spectrometer (RPS) data will be automated at the SOC within 6 months after launch. Raw instrument data and spacecraft attitude, ephemeris, and timing data will be obtained from the MOC by the RPS SOC. Instrument data will include a combination of singles rates, coincidence rates, and pulse-height analyzed event packets. Singles rates provide state-of-health, background, dead time, and calibration information. Coincidence rates identify the rate of direct events that satisfy the nominal 10-fold and 11-fold coincidence conditions. Event packets provide detailed information about how much energy was deposited in each of 8 solid-state detectors or, how much light was produced in the Cherenkov radiator, and the time of the event. Due to limitations of spacecraft telemetry, it may be the case that not all foreground events are transmitted to the ground in event packets. Event data will be used to determine the energy and angular form of the energetic proton environment local to the spacecraft. Coincidence rates will be used, as needed, to determine the absolute intensities (proton fluxes). Particle fluxes will be associated with magnetic coordinates and adiabatic invariants and converted into phase-space densities.

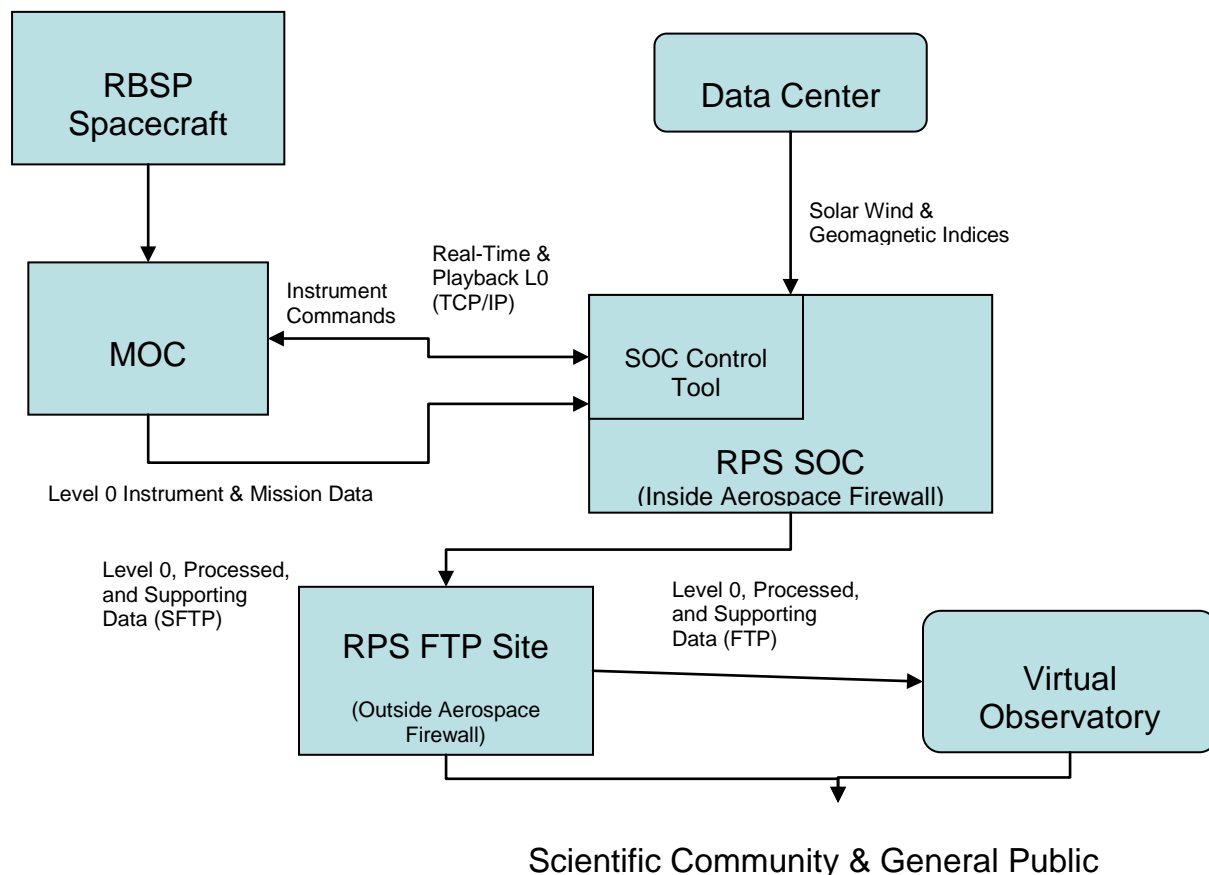

FSCM NO. <b>88898</b>	SIZE <b>A</b>	DRAWING NO. <b>7417-9129</b>	REV. <b>A</b>
SCALE	DO NOT SCALE PRINT		SHEET 34 of 78

Figure 3.2.5.a Overall flow chart of the PSBR SOC

**3.2.5.1 COMMANDING AND HEALTH AND SAFETY OPERATIONS**

The SOC, hosted at Aerospace, El Segundo, will obtain daily RBSP files from the MOC via the Internet with modem backup. Status displays, automated state-of-health monitoring, and manual/scheduled upload of commands will be managed through the “RPS SOC Control Tool” based on GSEOS with additional scripting.

**3.2.5.2 DATA PROCESSING, ARCHIVING, AND DISSEMINATION**

Detailed data processing will be executed on Aerospace’s High Performance Technical Computing cluster. Processing algorithms will be prototyped in IDL or Matlab, and processor intensive operations (e.g., magnetic field tracing, spectral inversion) will be performed with FORTRAN or C libraries (e.g., the IRBEM Library). Initial data processing will be performed with orbit/attitude/UTC predictions and a model magnetic field. Data will be reprocessed multiple times as attitude, MET to UTC, magnetic field vectors, and geomagnetic/interplanetary data need to run the global magnetic field models for high level data products become available. Processed data will be pushed to the Website as they become available

FSCM NO. <b>88898</b>	SIZE <b>A</b>	DRAWING NO. <b>7417-9129</b>	REV. <b>A</b>
SCALE	DO NOT SCALE PRINT	SHEET 35 of 78	

## 4 DATAPRODUCTS

### 4.1 DEFINITIONS OF DATA

NASA categorizes Data Products based on a system of Levels starting with Level zero. A level zero data product is usually defined as representing raw, but cleaned spacecraft telemetry; subsequent data levels represent successive levels of data processing involving calibration and the application of science algorithms. The RBSP mission has defined five data levels that are described in the table below (table 4.2). The suggested latency is an indication of the complexity in producing these products some of which would require careful analysis and verification.

Data Level	Brief Description	Latency Goal
L0	Reconstructed, unprocessed instrument data at full resolution; any and all communications artifacts, e.g., synchronization frames, communications headers, duplicate data removed.	N/A
L1	Instrument count rates at full resolution with supporting ancillary data (such as spacecraft ephemeris) needed for further processing. L1 data can be further split into L1A and L1B; L1B data would be calibrated L1 data needed to support L2 processing	14 Days
L2	Calibrated data presented in the appropriate scientific units and transformed into relevant geophysical coordinate systems.	30 Days
L3	Calibrated, re-sampled, averaged data that has been irreversible transformed to the point that lower level data cannot be reconstructed.	90 Days
L4	Higher level data products that require significant effort in processing and involve the use of models and additional external data sets. These products may be produced for a subset of the complete dataset only	1 Year

Table 4.1 RBSP mission defined data product levels

Notes:

- Data levels do not have a direct correspondence to “Quick Look” and “Final Data”, terms used in the Mission Requirements Document. “Quick Look” and “Final Data” can be derived from any data level beyond level zero – the definitions of “Quick Look” and “Final” are independent of this table (definitions are provided below).
- The tables below provide suggested data latencies that are not required, but rather are independent of the required data latencies for Quick Look and Final Data products as

FSCM NO. <b>88898</b>	SIZE <b>A</b>	DRAWING NO. <b>7417-9129</b>	REV. <b>A</b>
SCALE	DO NOT SCALE PRINT	SHEET 36 of 78	

references in the Mission Requirements Document. Both required and suggested latencies will likely be surpassed once automated data processing is in place.

Data levels are defined as a “best match” to existing NASA missions. The detailed descriptions of the data products (sorted by level) for the individual instrument teams are given in the following sections. A summary of these products is given at a mission level in Table 4.2

Data Level	ECT	EFW	EMFISIS	RBSPICE	RPS
L0	Raw Telemetry (Raw de-commutated telemetry received from MOC)	Raw Telemetry (Raw de-commutated telemetry received from MOC)	Raw Telemetry (Raw de-commutated telemetry received from MOC)	Raw Telemetry (Raw de-commutated telemetry received from MOC)	Raw Telemetry (Raw de-commutated telemetry received from MOC)
L1	Count Rates (Sorted time tagged instrument separated counts per second)	Time Tagged Raw waveform and spectral data (Expressed in spinning spacecraft coordinate system)	Time series and spectra (relative amplitudes); burst data	Count Rates (Sorted time tagged instrument separated counts per second)	Energy/Photon deposits, singles and coincidence rates  (Time tagged in UTC, magnetic field vector, minimal magnetic coordinates)
			Calibrated Magnetic Field values (Calibrated and corrected physical units)		
L2	Calibrated Flux (Calibrated and corrected physical units)	Calibrated Waveform and Spectral Data (In despun spacecraft coordinate system and other relevant geophysical Systems)	Spectral Quantities (Calibrated and corrected physical units); Includes low frequency spectra from MAG	Calibrated Flux (Calibrated and corrected physical units)	Flux versus Energy Spectrum
L3	Pitch Angle and Moments (Pitch angle distributions and moments of the plasma distribution)	Calibrated Waveform and Spectral Data (with $V \times B$ subtraction for DC E-field estimate)	Magnetic wave parameters	Pitch Angle and Moments (Pitch angle distributions and moments of the plasma distribution)	Energy-pitch angle spectrum and magnetic coordinates
L4	Phase Space Density (PSD units in adiabatic coordinate space)	Global Electric Field Pattern	Wave propagation parameters (Spectral matrices, WNA, polarization, Poynting flux, etc)  Electron densities	Phase Space Density (PSD units in adiabatic coordinate space) (PSD will be calculated for specific ring current relevant observations)	Global Maps (flux vs $E/K/\Phi$ and PSD versus $M/K/\Phi$ )

Table 4.2. Mission Level Data Products

#### 4.1.1 DEFINITIONS OF QUICK-LOOK AND FINAL DATA PRODUCTS

FSCM NO. <b>88898</b>	SIZE <b>A</b>	DRAWING NO. <b>7417-9129</b>	REV. <b>A</b>
SCALE	DO NOT SCALE PRINT		SHEET 37 of 78

*Quick Look Data*

The intention of quick look data is to provide a scientifically useful data product within a few days of acquiring data. The data are considered preliminary and cannot be cited, published or presented without the permission of the Principal Investigator.

Quick look data can be deleted or replaced once final calibrated data is available

*Final Data*

Final data is defined as final calibrated data delivered to the public, but is subject to revision and recalibration as described in section 4.2.

FSCM NO. <b>88898</b>	SIZE <b>A</b>	DRAWING NO. <b>7417-9129</b>	REV. <b>A</b>
SCALE	DO NOT SCALE PRINT	SHEET 38 of 78	

### 4.1.2 ECT

The ECT suite is comprised of three energetic particle instruments:

- REPT (Relativistic Electron-Proton Telescope), providing directional measurements of 1- >10MeV electrons and 17~200 MeV protons.
- MagEIS (Magnetic Electron Ion Spectrometer), providing directional measurements
- HOPE (Helium, Oxygen, proton and Electron), providing directional measurements of 1eV-50 KeV ions and electrons

The table below gives a high level overview of the data types ECT will be generating for all three instruments. L0 and L1 data are intended for ECT team audience only, while L2 data onwards are intended for public release. Unless otherwise noted the native cadence of all these data is the spacecraft spin period or close to that.

All flux data (L2, L3) will be provided as differential number flux particles/cm<sup>2</sup>-s-sr-E where E is KeV for HOPE and MeV for MagEIS and REPT. In addition, we will calculate numerical moments for the HOPE data (density, n, particles/cm<sup>3</sup> and temperature, T, keV).

Pitch angle resolved data products will have a common set of pitch angle bins (9): 0-20, 20-40, 40-60, 60-80 80-100,100-120,120-140, 140-160, 160-180 degrees.

L4 data products will be provided as Phase Space Density (PSD in particles c<sup>3</sup> / cm<sup>3</sup> MeV<sup>3</sup> where c is the speed of light). Provision of L4 data is not an RBSP requirement.

Data Level	Product Title	Contents	Volume	Format	Latency	Frequency
L0	Raw telemetry	Raw de-commutated telemetry received at ECT-SOC	450 MB / day - TBR	Binary	from Receipt (T <sub>0</sub> )	daily
L1	Count Rates	Sorted, time-tagged, instrument separated cts/sec	810 MB / day - TBR	ISTP Compliant CDF	T <sub>0</sub> + <6 hours	daily
L2	Calibrated Flux	Calibrated and corrected physical units	810 MB / day - TBR	ISTP Compliant CDF	T <sub>0</sub> + < 2 weeks	daily
L3	Pitch Angle and Moments	Pitch angle distributions, plasma moments	1310 MB / day - TBR	ISTP Compliant CDF	T <sub>0</sub> + < 2 months*	daily
L4	Phase Space Density	PSD units, adiabatic invariants, mag coords	27 MB / day	ISTP Compliant CDF	T <sub>0</sub> + < 1 year	daily

\* Longer during first 3 months of mission.

FSCM NO. <b>88898</b>	SIZE <b>A</b>	DRAWING NO. <b>7417-9129</b>	REV. <b>A</b>
SCALE	DO NOT SCALE PRINT	SHEET	39 of 78

#### 4.1.2.1 REPT

REPT natively collects data in 12 electron and 8 proton energy channels and the L2-L3 data products will be organized by these channels.

Channel Number	Electrons (MeV)	Protons (MeV)
1	1.6 – 2.0	18.5 – 24.0
2	2.0 – 2.5	24.0 – 31.2
3	2.5 – 3.2	31.2 – 40.6
4	3.2 – 4.0	40.6 – 52.8
5	4.0 – 5.0	52.8 – 68.6
6	5.0 – 6.2	68.6 – 89.2
7	6.2 – 7.7	89.2 – 116.0
8	7.7 – 9.7	> 116.0
9	9.7 – 12.1	
10	12.1 – 15.1	
11	15.1 – 18.9	
12	> 18.9	

Additional data products may be available on demand that take advantage of the high native angular resolution of REP (36 sectors).

#### 4.1.2.2 MAGEIS

MagEIS consists of 4 independent units dedicated to specific energy ranges and look directions:

- One low (energy) spectrometer with FOV centered 75 degrees to the spin axis, covering 45 – 200 KeV electrons in 9 energy channels (mageisLOW).
- Two medium (energy) spectrometers with FOVs centered at 75 and 35 degrees (Multiple medium (energy) spectrometers for enhanced pitch-angle coverage), covering 200 – 1000 keV electrons, in 9 energy channels (mageisM35 and mageisM75).

FSCM NO. <b>88898</b>	SIZE <b>A</b>	DRAWING NO. <b>7417-9129</b>	REV. <b>A</b>
SCALE	DO NOT SCALE PRINT	SHEET 40 of 78	



- One high (energy) spectrometer with FOV centered at 75 degrees, covering 1 – 4 MeV electrons in 8 energy channels and 0.1 – 10 MeV Protons in 11 energy channels (mageisHIGH).

L2 and L3 files will be produced for each MagEIS unit and one common set of files will be produced that contain the combined energy ranges from all units.

FSCM NO. <b>88898</b>	SIZE <b>A</b>	DRAWING NO. <b>7417-9129</b>	REV. <b>A</b>
SCALE	DO NOT SCALE PRINT		SHEET 41 of 78

Channel Number	MagEISLOW Electrons (MeV)	MagEISM35/M75 electrons (MeV)	MagEISHIGH electrons (MeV)	MagEISHIGH protons (MeV)
1	0.020	0.150	0.721	0.06
2	0.036	0.234	0.989	0.07
3	0.058	0.328	1.253	0.081
4	0.080	0.441	1.536	0.094
5	0.111	0.547	1.942	0.109
6	0.146	0.698	2.521	0.127
7	0.185	0.845	3.157	0.147
8	0.221	1.012	3.869	0.171
9	0.028	0.189	n/a	0.199
10	0.046	0.280	n/a	0.231
11	0.068	0.382	n/a	0.268
12	0.095	0.492	n/a	0.312
13	0.128	0.620	n/a	0.362
14	0.164	0.771	n/a	0.421
15	n/a	n/a	n/a	0.489
16	n/a	n/a	n/a	0.567
17	n/a	n/a	n/a	0.659
18	n/a	n/a	n/a	0.766
19	n/a	n/a	n/a	0.889
20	n/a	n/a	n/a	1.033
21	n/a	n/a	n/a	1.200

FSCM NO. <b>88898</b>	SIZE <b>A</b>	DRAWING NO. <b>7417-9129</b>	REV. <b>A</b>
SCALE	DO NOT SCALE PRINT	SHEET 42 of 78	

### 4.1.2.3 HOPE

HOPE is not spin synced but free running with a basic data acquisition cycle of 12 seconds to obtain one full scan in energy over 16 angular sectors. Nominally this acquisition time is the same as the spin, but no syncing takes place. HOPE can adjust this time within some range in order to track the spin period.

The normal operational mode for HOPE is one acquisition cycle for electrons, followed by one for ions. The native resolution for HOPE data is thus 12 seconds, and the cadence is 24 seconds. Given below are the current, somewhat nominal energy channel assignments for the 36 standard energy channels that HOPE will report. Energies may also vary a little from spacecraft A to B.

Channel Number	Energy Range (eV)	Channel Number	Energy Range (eV)
1	0.92 – 1.25	19	224.45 – 300.58
2	1.25 – 1.71	20	304.62 – 407.48
3	1.69 – 2.31	21	413.41 – 552.39
4	2.30 – 3.14	22	561.06 – 748.82
5	3.12 – 4.25	23	761.44 – 1015.1
6	4.24 – 5.76	24	1033.4 – 1376.1
7	5.75 – 7.80	25	1402.4 – 1865.4
8	7.80 – 10.57	26	1903.3 – 2528.9
9	10.59 – 14.34	27	2583.1 – 3428.1
10	14.37 – 19.44	28	3505.7 – 4647.2
11	19.50 – 26.36	29	4757.4 – 6299.9
12	26.47 – 35.73	30	6456.9 – 8540.1
13	35.92 – 48.43	31	8763.0 – 11577

FSCM NO. <b>88898</b>	SIZE <b>A</b>	DRAWING NO. <b>7417-9129</b>	REV. <b>A</b>
SCALE	DO NOT SCALE PRINT	SHEET 43 of 78	

14	48.75 – 65.66	32	11892 – 15694
15	66.16 – 89.00	33	16140 – 21275
16	89.79 – 120.66	34	21904 – 28841
17	121.86 – 163.57	35	29728 – 39097
18	165.38 – 221.73	36	40345 - 53000

FSCM NO. <b>88898</b>	SIZE <b>A</b>	DRAWING NO. <b>7417-9129</b>	REV. <b>A</b>
SCALE	DO NOT SCALE PRINT		SHEET 44 of 78

### 4.1.3 EFW

Data Level	Product Title	Contents	Volume	Format	Latency	Frequency
L0	Raw telemetry.	Raw de-commutated telemetry data retrieved from MOC.  APID-separated daily files generated by MOC (L0)..	130 MB/day/SC	Binary	T <sub>0</sub> + < 6 hours	Daily
L1	Waveform and spectral data (survey and burst).	L0 + Time-tagged RAW waveform and spectral data in spinning spacecraft coordinate system.  Waveform data Includes individual sensor voltages (V channels), differential potentials (E channels), and searchcoil (MSC channels).  Spectral data includes FilterBank and FFT spectra and cross-spectra.  IDL/TDAS and SDT Software and CALPAR files read L1 data files and produce data in physical units.	520 MB/day/SC	ISTP Compliant CDF	T <sub>0</sub> + < 6 hours	Daily
L2	Calibrated waveform and spectral data (survey and burst).	L1 + Time-tagged waveform and spectral data in calibrated physical units [V, mV/m, nT, (V/m) <sup>2</sup> -Hz <sup>-1</sup> , etc.] in despun spacecraft coordinate system and relevant geophysical coordinate systems (4 total).  E-field estimates include versions with rough -VxB removal to allow for easier identification of fluctuations at lower altitudes.	2.1 GB/day/SC	ISTP Compliant CDF	T <sub>0</sub> + < 1 week	Daily
L3	Calibrated waveform data with -VxB removal.	L2 + precision VxB removal for DC E-field estimate (same coordinate systems as L2, plus -VxB in corotation and inertial system).	3.1 GB/day/SC	ISTP Compliant CDF	T <sub>0</sub> + < 1 month	Daily
L4	Higher-level derived products.	L3 + global E field pattern estimates	Negligible additional volume  (<1 MB/day)	ISTP Compliant CDF (TBR)	T <sub>0</sub> + < 1 year	Daily

EMFISIS

FSCM NO. <b>88898</b>	SIZE <b>A</b>	DRAWING NO. <b>7417-9129</b>	REV. <b>A</b>
SCALE	DO NOT SCALE PRINT	SHEET	45 of 78

#### 4.1.4 EMFISIS

Data Level	Product Title	Contents	Volume	Format	Latency	Frequency
L0	Raw telemetry	Raw EMFISIS data including both science and HK data	500 Mbytes per day per spacecraft	Binary/ ISTP Compliant CDF	Minutes from availability at MOC (T <sub>0</sub> )	Daily
L1	Time series and spectra; burst data	Time series and spectra (relative amplitudes); burst data  Calibrated DC Magnetic Field values (calibrated and corrected physical units)	750 Mbytes per day per spacecraft	ISTP Compliant CDF	T <sub>0</sub> + <8 days	Daily
L2	Calibrated time series, spectra and burst data	Spectral Quantities (Calibrated and corrected physical units); Includes low frequency spectra from MAG	850 Mbytes per day per spacecraft	ISTP Compliant CDF	T <sub>0</sub> + <60 days (14 days for MAG)	Daily
L3	Lower level derive products	Magnetic wave parameters	850 Mbytes per day per spacecraft	ISTP Compliant CDF	T <sub>0</sub> + <4 months	Daily
L4	Higher level derived products	Wave propagation parameters (Spectral matrices, WNA, polarization, Poynting flux, etc.)  Electron densities	1250 Mbytes per day per spacecraft	ISTP Compliant CDF	T <sub>0</sub> + <1 year	Daily

##### 4.1.4.1 EMFISIS DATA PRODUCTS BY LEVEL

1. L1 Time series and spectra; burst data      Time series and spectra (relative amplitudes); burst data  
Calibrated DC Magnetic Field values (calibrated and corrected physical units)
  - a. L1a rbsp-X-emfisis\_mag-290\_L1a-sen\_20XX-XX-XX\_v1.1.1.1.cdf
    - MAG\_XYZ – Vector in the spacecraft coordinate system at the sensor, nT
    - Magnitude – Magnitude of the vector, nT
  - b. L1b rbsp-X-emfisis\_mag-290\_L1b-uvw\_20XX-XX-XX\_v1.1.1.1.cdf
    - MAG\_XYZ – Vector in the scientific coordinate system, nT
    - Magnitude – Magnitude of the vector, nT
    - Delta – Angle delta of the vector, degrees
    - Lambda – Angle lambda of the vector, degrees
  - c. L1b rbsp-X-emfisis\_mag-290\_L1b-xyz\_20XX-XX-XX\_v1.1.1.1.cdf
    - MAG\_XYZ – Vector in the spacecraft coordinate system, nT
    - Magnitude – Magnitude of the vector, nT
    - Delta – Angle delta of the vector, degrees
    - Lambda – Angle lambda of the vector, degrees

FSCM NO. <b>88898</b>	SIZE <b>A</b>	DRAWING NO. <b>7417-9129</b>	REV. <b>A</b>
SCALE	DO NOT SCALE PRINT	SHEET	46 of 78

2. L2 Calibrated time series, spectra and burst data      Spectral Quantities (Calibrated and corrected physical units); Includes low frequency spectra from MAG
- a. L2 rbsp-a\_30ms-spectral-matrix\_emfisis\_20XXXXXXX\_v1.1.1.cdf
    - BuBu – Autocorrelation of this component,  $nT^2/Hz$
    - BvBv – Autocorrelation of this component,  $nT^2/Hz$
    - BwBw – Autocorrelation of this component,  $nT^2/Hz$
    - EuEu – Autocorrelation of this component,  $(V/m)^2/Hz$
    - EvEv – Autocorrelation of this component,  $(V/m)^2/Hz$
    - EwEw – Autocorrelation of this component,  $(V/m)^2/Hz$
    - BuBv – Cross multiply of components,  $nT^2/Hz$  (complex)
    - BuEu – Cross multiply of components,  $nT-V/m-Hz$  (complex)
    - BuEv – Cross multiply of components,  $nT-V/m-Hz$  (complex)
    - BuEw – Cross multiply of components,  $nT-V/m-Hz$  (complex)
    - BvBw – Cross multiply of components,  $nT^2/Hz$  (complex)
    - BvEw – Cross multiply of components,  $nT-V/m-Hz$  (complex)
    - BwEu – Complex multiply of components,  $dbVrms$  (complex)
    - BwEv – Cross multiply of components,  $nT-V/m-Hz$  (complex)
    - BwEw – Cross multiply of components,  $nT-V/m-Hz$  (complex)
    - EuEv – Cross multiply of components,  $(V/m)^2/Hz$ (complex)
    - EuEw – Cross multiply of components,  $(V/m)^2/Hz$ (complex)
    - EvEw – Cross multiply of components,  $(V/m)^2/Hz$ (complex)
  - b. L2 rbsp-a\_HFR-spectra-burst\_emfisis\_20XXXXXXX\_v1.1.1.cdf
    - HFR\_Spectra – Autocorrelation single component,  $(V/m)^2/Hz$
  - c. L2 rbsp-a\_HFR-spectra\_emfisis\_20XXXXXXX\_v1.1.1.cdf
    - HFR\_Spectra – Autocorrelation single component,  $(V/m)^2/Hz$
  - d. L2 rbsp-a\_HFR-waveform\_emfisis\_20XXXXXXX\_v1.1.1.cdf
    - HFRSamples – Electric field,  $V/m$
  - e. L2 rbsp-a\_WFR-spectral-matrix-burst\_emfisis\_20XXXXXXX\_v1.1.1.cdf
    - Same as 30ms mode
  - f. L2 rbsp-a\_WFR-spectral-matrix\_emfisis\_20XXXXXXX\_v1.1.1.cdf
    - Same as 30ms mode
  - g. L2 rbsp-a\_WFR-waveform-burst\_emfisis\_20XXXXXXX\_v1.1.1.cdf
    - Bu – Magnetic field,  $nT$
    - Bv – Magnetic field,  $nT$
    - Bw – Magnetic field,  $nT$
    - Eu – Electric field,  $V/m$
    - Ev – Electric field,  $V/m$
    - Ew – Electric field,  $V/m$
  - h. L2 rbsp-a\_WFR-waveform\_emfisis\_20XXXXXXX\_v1.1.1.cdf
    - Bu – Magnetic field,  $nT$
    - Bv – Magnetic field,  $nT$
    - Bw – Magnetic field,  $nT$
    - Eu – Electric field,  $V/m$
    - Ev – Electric field,  $V/m$
    - Ew – Electric field,  $V/m$
  - i. L2 rbsp-a\_WNA\_emfisis\_20XXXXXXX\_v1.1.1.cdf
    - $B^2$  – Squared magnetic field magnitude,  $(V/m)^2$
    - $E^2$  – Squared electric field magnitude,  $nT^2$

FSCM NO. <b>88898</b>	SIZE <b>A</b>	DRAWING NO. <b>7417-9129</b>	REV. <b>A</b>
SCALE	DO NOT SCALE PRINT	SHEET 47 of 78	

- Sx – Poynting Flux , W/m<sup>2</sup>
  - Sy – Poynting Flux , W/m<sup>2</sup>
  - Sz – Poynting Flux , W/m<sup>2</sup>
  - Eigenvalues – component values, arbitrary units
- j. L2 rbsp-a\_housekeeping\_emfisis\_20XXXXXX\_v1.1.1.cdf
- AD MUX Channel 00, +1.8V Monitor (Digital), Volts
  - AD MUX Channel 01, +3.3V Monitor (Digital), Volts
  - AD MUX Channel 02, +5V Monitor (Digital), Volts
  - AD MUX Channel 02, -5V Monitor (Digital), Volts
  - AD MUX Channel 02, +5.5V Monitor unregulated (Digital), Volts
  - AD MUX Channel 02, -5.5V Monitor unregulated (Digital), Volts
  - AD MUX Channel 06, +20V Monitor unregulated (Digital), Volts
  - AD MUX Channel 07, -20V Monitor unregulated (Digital), Volts
  - AD MUX Channel 08, +12V Monitor (Analog), Volts
  - AD MUX Channel 09, -12V Monitor (Analog), Volts
  - AD MUX Channel 10, +13.8V Monitor (Analog), Volts
  - AD MUX Channel 11, -13.8V Monitor (Analog), Volts
  - AD MUX Channel 12, +15V Monitor (Analog), Volts
  - AD MUX Channel 13, -15V Monitor (Analog), Volts
  - AD MUX Channel 14, +20V Monitor unregulated (Analog), Volts
  - AD MUX Channel 15, -20V Monitor unregulated (Analog), Volts
  - AD MUX Channel 16, +2.5V Internal Reference (Digital), Volts
  - AD MUX Channel 17, +2.5V Internal Reference (Analog), Volts
  - AD MUX Channel 18, +5.5V Current Monitor (Digital), mA
  - AD MUX Channel 19, Ground, Volts
  - AD MUX Channel 20, +1.8V Current Monitor (Digital), mA
  - AD MUX Channel 21, +3.3V Current Monitor (Digital), mA
  - AD MUX Channel 22, Magnetometer Heater Power, %Pwr
  - AD MUX Channel 23, Magnetometer Temperature, degrees C
  - AD MUX Channel 24, +/- 12V Current Monitor (Analog), mA
  - AD MUX Channel 25, +/- 15V Current Monitor (Analog), mA
  - AD MUX Channel 26, +/- 13.8V Current Monitor (Analog), mA
  - AD MUX Channel 27, + 5V Current Monitor (Digital), mA
  - AD MUX Channel 28, Ground, Volts
  - AD MUX Channel 29, Ground, Volts
  - AD MUX Channel 30, Ground, Volts
  - AD MUX Channel 31, Ground, Volts
  - Operating State of the CDPU, RAW
  - 16 bits of CDPU Status flags, RAW
  - commandsAccepted Epoch time\_series commandsAccepted RAW
  - commandsRejected Epoch time\_series commandsRejected RAW
  - Last command opcode and flags, RAW
  - subcomCounter, RAW
  - 20 bits of CDPU flags, RAW
  - 32 bits of CDPU data, subcommed, RAW
  - Magnetometer zero crossing time in MET – seconds, seconds
  - Magnetometer zero crossing time in MET – subseconds, RAW
  - Magnetometer range, RAW

FSCM NO. <b>88898</b>	SIZE <b>A</b>	DRAWING NO. <b>7417-9129</b>	REV. <b>A</b>
SCALE	DO NOT SCALE PRINT	SHEET	48 of 78



- Shared Data Valid flag, RAW
  - Burst Data Type, RAW
  - Burst Triggering, RAW
  - External Trigger status, RAW
  - Hope Bit, RAW
  - Targeted Burst Chorus, RAW
  - Targeted Burst Shock, RAW
  - 3 bits of chorus quality, RAW
  - 2 bits of shock event quality, RAW
3. L3 Lower level derive products      Magnetic wave parameter
  4. L4 Higher level derived products      Wave propagation parameters (Spectral matrices, WNA, polarization, Poynting flux, etc. ) Electron densities

#### 4.1.5 RBSPICE

Data Level	Product Title	Contents	Volume	Format	Latency	Frequency
L0	Raw telemetry	Raw de-commutated telemetry received at RBSPICE-SOC	414 MB / day - TBR	Binary	from Receipt (T <sub>0</sub> )	daily
L1	Count Rates	Sorted, time-tagged, instrument separated cts/sec	750 MB / day - TBR	ISTP Compliant CDF & ASCII (CSV)	T <sub>0</sub> + < 14 days	daily
L2	Calibrated Flux	Calibrated and corrected physical units	1200 MB / day - TBR	ISTP Compliant CDF & ASCII (CSV)	T <sub>0</sub> + < 1 month	daily
L3	Pitch Angle and Moments	Pitch angle distributions, plasma moments	1500 MB / day - TBR	ISTP Compliant CDF & ASCII (CSV)	T <sub>0</sub> + < 3 months*	daily
L4	Phase Space Density	PSD units, adiabatic invariants, mag coords	30 MB / day	ISTP Compliant CDF & ASCII (CSV)	T <sub>0</sub> + < 1 year	daily

- Longer during first 3 months of mission.

FSCM NO. <b>88898</b>	SIZE <b>A</b>	DRAWING NO. <b>7417-9129</b>	REV. <b>A</b>
SCALE	DO NOT SCALE PRINT		SHEET 49 of 78

#### 4.1.6 PSBR/RPS

Data Level	Product Title	Contents	Volume	Format	Latency*	Frequency
L0	Level 0 Data	RPS PTP/CCSDS packets (decoded in CDF version, includes space weather data)	50 Mb/day/pr obe	Binary & nearly-ISTP Compliant CDF	$T_0 + < 3$ days	Daily
L1	Level 1 Data	Nearly all L0 data, UTC, energy/photon deposits, singles and coincidence rates, s/c location, RPS boresight vector, magnetic field vector, dead times (including quota effects), minimal OPQ coordinates	<65 Mb/day/pr obe (max size during solar particle event)	ISTP Compliant CDF	$T_0 + < 3$ days	Daily
L2	Energy Spectra	UTC, flux versus energy spectrum (73/spin), pitch-angle and full magnetic coordinates (e.g., $L_m$ , MLT, $I$ , $B_{local}$ , $B_{equ}$ , $\Phi$ ) of RPS boresight in OPQ, T89Q, T89, and TS04 models	80 (TBR) Mb/day/pr obe	ISTP Compliant CDF	$T_0 + < 5$ days	Daily
L3	Energy-Angle Spectra	UTC, energy-pitch angle spectrum (once per spin and once per minute), full magnetic coordinates in OPQ, T89Q, T89, and TS04	20 (TBR) Mb/day/pr obe	ISTP Compliant CDF	$T_0 + < 7$ days	Daily
L4	Global Maps	UTC, flux vs $E/\alpha_{eq}/L_m$ , flux vs $E/K/\Phi$ , PSD vs $M/K/\Phi$ maps (once per orbit leg) in OPQ, T89Q, T89, and TS04 models	1 (TBR) Mb/day/pr obe	ISTP Compliant CDF	$T_0 + < 9$ days	Daily

\*Latency applies to data availability schedule after processing is fully automated.

Definition of Energy Channels: 20 channels, logarithmically spaced from 65 MeV (lowest channel center) to 1.2 GeV (highest channel center).

Pitch angle resolution 5 degrees (TBR)

Magnetic field models used for L2 and higher data products: Olson Pfitzer Quiet (OPQ), Tsyganenko 89 (T89) with fixed  $K_p=2$  (denoted T89Q), T89 with observed  $K_p$ , and Tsyganenko-Sitnov 2004 (TS04).

Reference documents:

- PSBR-01212 PSBR Project Data management Plan (PDMP)
- PSBR-01216 PSBR/RPS Science Operations Center and Data Processing Requirements and Specification (DPRS)

FSCM NO. <b>88898</b>	SIZE <b>A</b>	DRAWING NO. <b>7417-9129</b>	REV. <b>A</b>
SCALE	DO NOT SCALE PRINT	SHEET	50 of 78

- PSBR-01219 RPS Level 0 PTP to CDF Conversion
- PSBR-01221 Level 0 to Level 1 Data Processing
- PSBR-01222 Level 1 to Level 2 Data Processing
- PSBR-01223 Level 2 to Level 3 Data Processing
- PSBR-01224 Level 3 to Level 4 Data Processing

FSCM NO. <b>88898</b>	SIZE <b>A</b>	DRAWING NO. <b>7417-9129</b>	REV. <b>A</b>
SCALE	DO NOT SCALE PRINT	SHEET 51 of 78	

## 4.2 MAPPING OF DATA PRODUCT TYPES

The tables below map from a particular data product (Such as a particle species spectra) to a specific RBSP Instrument suite and data level.

### PARTICLES

Data Product	Instrument Suite	Data Product Level
Electron intensity versus energy and time	ECT	L2
	RBSPICE	L2
Electron Intensity versus pitch angle and time	ECT	L3
	RBSPICE	L3
(P)roton (He)lium (O)xygen versus energy and time	ECT	L2
	RBSPICE	L2
	PSBR	L2
(P)roton (He)lium (O)xygen versus pitch angle and time	ECT	L3
	RBSPICE	L3
	PSBR	L3
(P)roton (He)lium (O)xygen versus gyrophase and time	ECT	L3
	RBSPICE	L3
	PSBR	L3
Selected E,P, He, O energy spectra	ECT	L2
	RBSPICE	L2
	PSBR	
Selected E,P, He, O pitch angle distributions	ECT	L3
	RBSPICE	L3

FSCM NO. <b>88898</b>	SIZE <b>A</b>	DRAWING NO. <b>7417-9129</b>	REV. <b>A</b>
SCALE	DO NOT SCALE PRINT	SHEET 52 of 78	

	PSBR	L3
Electrons: N, I, P, IE moments	ECT	L3
	RBSPICE	L3
P,He,O: N,V, I, P, E moments	ECT	L3
	RBSPICE	L3
HOPE distribution functions	ECT	L3
E,P, He, O, Phase-space density versus momentum or energy	ECT	L4
	RBSPICE	L4
E,P, He, O, Phase space density versus adiabatic invariants	ECT	L4
	RBSPICE	L4

#### 4.2.1 MAGNETIC FIELDS

Data Product	Instrument Suite	Data Product Level
Magnetic Field Components in spacecraft coordinates	EMFISIS	L1
Magnetic Field Components in GSE/GSM and other coordinate systems	EMFISIS	L2
ULF wave spectral components	EMFISIS	L3
Selected ULF wave spectral components	EMFISIS	L3

#### 4.2.2 ELECTRIC FIELD

Data Product	Instrument Suite	Data Product Level
Electric field components in spacecraft coordinates	EFW	L1
Electric field Components in GSE/GSM and other coordinate systems	EFW	L2
Electric field components with $E \cdot B = 0$ field subtracted	EFW	L3

FSCM NO. <b>88898</b>	SIZE <b>A</b>	DRAWING NO. <b>7417-9129</b>	REV. <b>A</b>
SCALE	DO NOT SCALE PRINT	SHEET 53 of 78	

ULF wave spectra versus time	EFW	L3
Selected ULF wave spectral components	EFW	L3

### 4.2.3 WAVES

Data Product	Instrument Suite	Data Product Level
Electric Field Spectra vs time	EFW	L3
Magnetic Field Spectra vs Time	EMFISIS	L2/L3
Selected Electric Field Spectra	EFW	L3
Selected Magnetic Field Spectra	EMFISIS	L2/L3
Wave Estimate of Ne		

FSCM NO. <b>88898</b>	SIZE <b>A</b>	DRAWING NO. <b>7417-9129</b>	REV. <b>A</b>
SCALE	DO NOT SCALE PRINT	SHEET 54 of 78	

### 4.3 MAGNETIC FIELD MODELS

The Magnetic models and Coordinates Committee (CooCoo) has defined a number of magnetic models used to generate the magnetic coordinate systems to be used for RBSP data in addition to the spacecraft (XYZ) and science (UVW) coordinate systems. The committee identified a variety of magnetic field models and a set of driving parameters for these models. These are then used to generate a coordinate system. The ECT SOC will generate ephemeris files using these coordinate systems and provides them to the other teams through their website.

The models selected are:

1. Olsen Pfitzer Quiet (OP77).
2. Tsyganenko 89 driven with  $K_p=2$ .
3. Tsyganenko 89 driven with observed  $K_p$ .
4. Tsyganenko-Sitnov 04 driven with observed solar wind parameters.

### 4.4 FILE FORMATS

The instrument teams have agreed to standardize on the use of the Common Data Format (CDF) for RBSP data products. The teams have also agreed to produce ISTP compliant CDF files (containing metadata defined by the ISTP program) and in the case of the particle instruments attempt to produce CDF files following the PRBEM (Panel on Radiation Belt Environment Modeling) standard.

The project will use version 3.4.1 of the CDF file format that supports the TT2000 variable type that deals with leap seconds. This will simplify the conversion of RBSP times. Several downstream analysis software packages used by the RBSP teams (such as TDAS) have been upgraded to support this version of the CDF file format.

FSCM NO. <b>88898</b>	SIZE <b>A</b>	DRAWING NO. <b>7417-9129</b>	REV. <b>A</b>
SCALE	DO NOT SCALE PRINT	SHEET 55 of 78	

#### 4.5 FILENAME CONVENTIONS

The filename is of the form:

<source>\_<type>\_<descriptor>\_<date>\_<version>.cdf

Field	Description	Example
<source>	Data source identifier, comprised of sub-fields for mission (“rbsp”), spacecraft (“a” or “b”), and optionally the instrument suite.	“rbsp-a-ect”, “rbsp-b-emfisis”, “rbsp-a”
<type>	Data type, comprised of sub-fields for a short mnemonic data type identifier.	“pre”, “fnl-001”
<descriptor>	A short descriptor of the data included in the file.	“mag-L2”, “rbspice-L3”, “rps-ap003-l3”
<date>	Start date of the file in Universal Coordinated Time (UTC). Dates can either be in the form, “[YYYY][MM][DD]” or “[YYYY][MM][DD]T[hh][mm]Z”.	“20120201”, “20120830T103000Z”
<version>	Version number consisting of the form “X.Y.Z-R”, where X is the major (interface) number, Y is the minor (quality number), Z is the revision number and R is an optional release number	“v1.1.1”, “v1.2.1”, v2.2.1-100”
.cdf	Filename suffix (“.cdf”)	“.cdf”

FSCM NO. <b>88898</b>	SIZE <b>A</b>	DRAWING NO. <b>7417-9129</b>	REV. <b>A</b>
SCALE	DO NOT SCALE PRINT	SHEET 56 of 78	



## 4.6 REVISION CONTROL

Data products are subject to both version and revision control. The data product version number indicates how many times the content or format for the product has changed. Modifications to processing software, changes to calibration or other input files, and product format changes are all examples that would cause the version number to increment. The data product revision number indicates how many times the product has been regenerated with the same processing software as well as the same input and calibration data files. Data entry errors, transmission problems or other types of failures may cause a product to be re-released and thus have the data product revision number incremented. The RBSP Instrument Teams will track both data product versions and data product revisions by incorporating that information into both the product filenames and in the appropriate meta-data.

## 4.7 DOCUMENTATION

### 4.7.1 ECT

For each of the ECT instruments, the ECT-SDC will provide an online, publicly accessible repository for the following documents:

- Instrument description (and links to published instrument papers).
- Calibration procedures and methods.
- Validation through cross-calibration between the RBSP spacecraft and cross-calibration with other assets (GPS, HEO, GEO).
- Description of each data product (this will also be available in the CDF file attributes).
- Meta-data products as needed for the Virtual Radiation Belt Observatory (ViRBO).

### 4.7.2 EFW

The EFW-SDC will provide an online, publicly accessible repository for the following documents:

- Instrument description (and links to published instrument papers).
- Calibration procedures and methods.
- Validation through cross-calibration between the Observatory ephemeris, EFW, ECT/HOPE, and EMFISIS/MAG data and ( $E = -V \times B$ ).
- Description of each data product (this will also be available in the CDF file attributes).

### 4.7.3 EMFISIS

For each of the EMFISIS data products produced, the EMFISIS SDC will provide an online, publicly accessible repository for the following documents:

FSCM NO. <b>88898</b>	SIZE <b>A</b>	DRAWING NO. <b>7417-9129</b>	REV. <b>A</b>
SCALE	DO NOT SCALE PRINT	SHEET 57 of 78	

- Instrument description (and links to published instrument papers).
- Calibration procedures and methods.
- Validation through cross-calibration between the RBSP spacecraft.
- Description of each data product (this will also be available in the CDF file attributes).

Descriptions of any meta-data products produced.

#### 4.7.4 RBSPICE

The RBSPICE SDC will provide an online, publicly accessible repository for the following documents:

- Instrument description (and links to published instrument papers).
- RBSPICE Data Analysis Handbook to include the following,
  - Calibration procedures and methods,
  - Validation through cross-calibration between the RBSP spacecraft and cross-calibration with other assets (GOES, POES, ACE),
  - Description of each data product.
- SPASE Meta-data product descriptions of each of the data level products and granular level SPASE descriptions of file contents as needed for the Virtual Radiation Belt Observatory (ViRBO).

#### 4.7.5 PSBR

The PSBR SOC will provide the following documents:

- An instrument description paper will be published in a peer-reviewed journal as part of a special section on RBSP instruments.
- Calibration data files and notes from calibration runs at beam facilities will be provided in the format used by the RPS team.
- A dataset description file (README) will be provided. This file will provide a user's guide to RPS L1-L4 data sets.
- Documents will be produced describing the processing of data L0 to L1, L1 to L2, L2 to L3, and L3 to L4. These documents will describe the algorithms used in the processing. Source code files will also be provided, contingent on approval from Aerospace's Software Release Committee.
- SPASE compliant meta-data will be generated to describe the RPS website (SDC), data files and personnel. The RBSP mission will provide SPASE compliant meta-data describing the RBSP mission and spacecraft.

FSCM NO. <b>88898</b>	SIZE <b>A</b>	DRAWING NO. <b>7417-9129</b>	REV. <b>A</b>
SCALE	DO NOT SCALE PRINT	SHEET 58 of 78	

## 4.8 PROCESSING AND ANALYSIS TOOLS

The RBSP instrument teams are using a number of general-purpose data analysis tools that will facilitate both the inter-comparison of RBSP data and other data sets. These include Autoplot, the Themis Data Analysis Toolkit (TDAS) and the Mission Independent Data Layer (MIDL).

### 4.8.1 RBSP SCIENCE GATEWAY

The RBSP Science Gateway (<http://athena.jhuapl.edu>) is the RBSP project website that provides public access to RBSP Science and ancillary data. The website provides registered users with access to summary plots, planning tools, links to the SOC websites, a series of discussion forums and a publication list. The site also serves as the primary method of accessing plots from the RBSP Space Weather data.

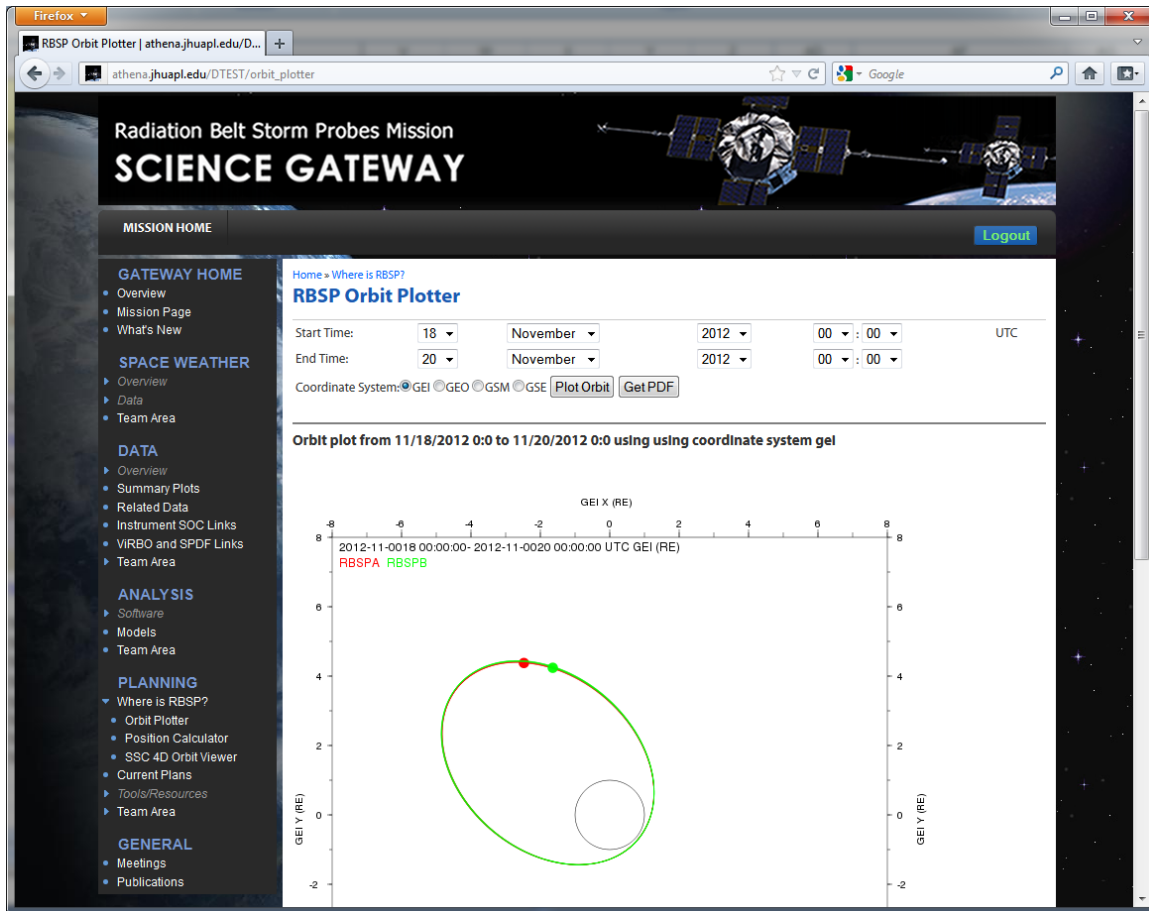

Figure 4.7.1.a The RBSP Science Gateway

FSCM NO. <b>88898</b>	SIZE <b>A</b>	DRAWING NO. <b>7417-9129</b>	REV. <b>A</b>
SCALE	DO NOT SCALE PRINT	SHEET	59 of 78

As some RBSP data must be restricted for operational reasons, the gateway features a tiered registration system with different classes of users: project team members, partners, and general users. By registering at the site and logging on, users gain access to the restricted parts of the site.

The site is designed to function as the central place for general science users to visit when searching for RBSP data. The site will feature RBSP summary data co-plotted for each instrument and AutoPlot “vap” files that can be used to retrieve and interactively plot data. The site features prominent links to the individual SOCs as well as SPDF and ViRBO.

The gateway also provides links to software tools and analysis software used by the RBSP instrument teams, include CDF, SPICE and TDAS. New analysis tools will be added to the gateway as they are developed.

The gateway also provides planning tools such as an orbit plotter (shown in figure 4.7.1a), a footprint plotter (which shows the RBSP footprint as traced along a magnetic field line to the ground), and a tool for finding conjunctions. The site also provides restricted access to a sub-set of mission operations data files (such as the spacecraft predicted ephemeris) to facilitate science planning.

The gateway also provides a host of ancillary information about RBSP science activities, including meeting lists, publications and links to presentations and papers. The site is built on the Drupal content management system and so allows registered users to add their own content and to participate in discussion boards. The intention is that the site becomes an RBSP community resource.

Finally the gateway will also serve plots of the RBSP Space Weather data in near real-time and provide an archive of plots.

#### 4.8.2 ECT

All higher-level data products will be produced at the ECT-SDC and distributed from there. Codes to process data from one level to another will be maintained and run at the ECT-SDC. The end user should have no need to run these codes. The codes will be made available on request but will not be supported outside the ECT-SDC environment.

Data will be in the common CDF format for which many readers and utilities exist in a variety of languages (IDL, Matlab, Fortran, C, Python). There is no intention to distribute dedicated readers in these languages. Additional formats used will be RichAscii (with JSON formatted Meta Data Headers) and HDF5. All the metadata in these formats will be compliant with the ISTP CDF Metadata standard.

Magnetic field models used will be publicly available models from the scientific community and maintained by their original authors. Tools for field line tracing, coordinate conversions, and the

FSCM NO. <b>88898</b>	SIZE <b>A</b>	DRAWING NO. <b>7417-9129</b>	REV. <b>A</b>
SCALE	DO NOT SCALE PRINT	SHEET 60 of 78	

calculation of magnetic coordinates will come from the LanlGeoMag library maintained at LANL, which is available to anyone on demand.

The ECT SOC has undertaken the responsibility of being the central provider of RBSP ephemeris in a variety of coordinate systems and magnetic coordinates. A set of these ephemeris files “Mag Ephem Files” has been produced for Mission SIM 3, together with a set of Autoplot PNGwalks for these data and a Description of the data file contents (and are available at the ECT SOC Website at

[http://www.rbsp-ect.lanl.gov/rbsp\\_ect.php](http://www.rbsp-ect.lanl.gov/rbsp_ect.php) (Data Products -> Magnetic Ephemerii)

The main data display, browse and analysis tool at the ECT SOC will be the publically available Autoplot package (<http://autoplot.org/>). Autoplot is a Java-based cross-platform tool that provides access to a wide variety of data as long as they are accessible on the Internet. Autoplot is generally launched, obtained and updated via a standard java-enabled web-browser such as Firefox or Safari and requires no additional user maintenance or installation (it used the Java Network Launch Protocol mechanism).

Autoplot has been supported by the ECT SOC and customized to ECT SOC requirements – in particular, to support higher rank data, plotting by orbit, RichASCII support, and many others. A new addition to Autoplot has been the PNGwalk viewer, a separate java-based plot browse application that replaces the traditional summary plot overview websites used for past missions.

The figure below shows the use of Autoplot at the ECT SOC website:

FSCM NO. <b>88898</b>	SIZE <b>A</b>	DRAWING NO. <b>7417-9129</b>	REV. <b>A</b>
SCALE	DO NOT SCALE PRINT	SHEET 61 of 78	

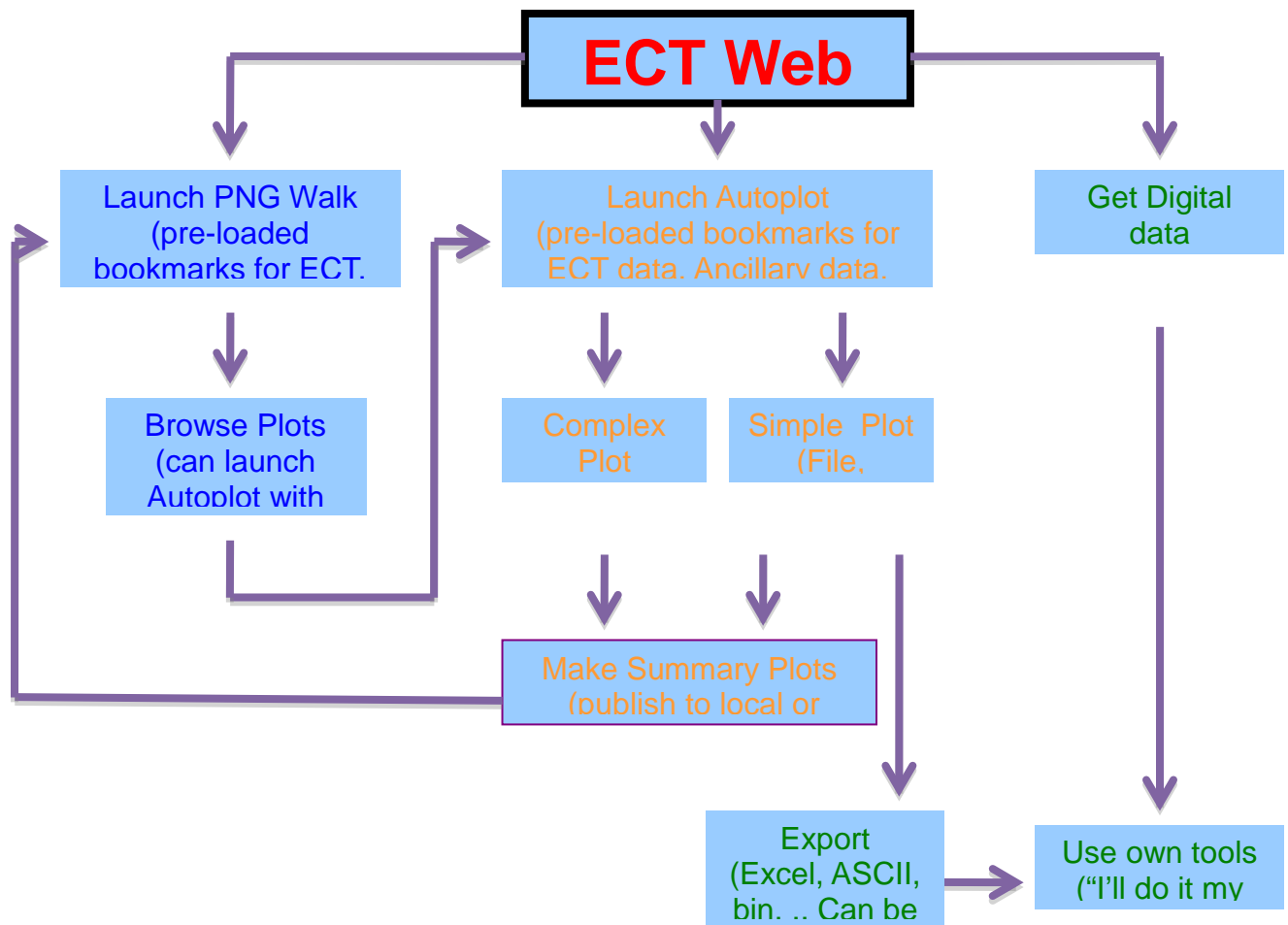

The user can obtain digital data directly from the LANL website, launch Autoplot with pre-defined plot products for detailed investigation or use the PNG Walk tool to browse large amounts of “canned” plots.

The ECT SOC intends to produce a limited set of daily summary plots for each instrument (spectra, pitch angle distributions, L-sorted, PSD at adiabatic invariants). The power of Autoplot is that each plot-type can be represented by a “bookmark”, and that a set of summary plots can easily be generated for any defined plot type – and that a user can define any plot type that he or she likes. The ECT SOC intends to add new bookmarks and canned summary plots as requested.

Autoplot is not intended to be a detailed analysis tool. Advanced Autoplot usage does allow the use of an Autoplot scripting tool for simple data manipulation. For any more sophisticated analysis or additional calculations we expect the user to download the ECT data files and to use their own favorite analysis package (Matlab, IDL, Python...). Autoplot allows data to be

FSCM NO. <b>88898</b>	SIZE <b>A</b>	DRAWING NO. <b>7417-9129</b>	REV. <b>A</b>
SCALE	DO NOT SCALE PRINT	SHEET 62 of 78	

exported to a variety of other file formats for those who do not wish to use CDF. The ECT SOC is happy to make available analysis packages used at LANL such as LANL GEO MAG, PAPCO (<http://www.papco.org/>) or SciPy (<http://www.scipy.org/>). However the ECT SOC is not able to provide user-support for these packages and can only provide help on a “best level of effort” basis.

### 4.8.3 EFW

All higher-level data products will be produced at the EFW-SDC and distributed from there. Codes to process data from one level to another will be maintained and run at the EFW-SDC. The end user should have no need to run these codes, but will have access to the codes for L1+ processing through the IDL/TDAS-based analysis tools.

Data will be in the common ISTP-Compliant CDF format for which many readers and utilities exist in a variety of languages (IDL, Matlab, Fortran, C, Python). There is no intention to distribute dedicated readers in these languages.

For the EFW science team, two data display and analysis packages, the C-based Science Data Toolkit (SDT), and the IDL-based set of EFW analysis routines from the THEMIS Data Analysis System (TDAS) will be provided. TDAS uses the IDL CDAWEB library from GSFC to access the CDF files (<http://spdf.gsfc.nasa.gov/CDAWlib.html>).

Both SDT and TDAS provide access to a host of other data through their modules, and can be used to display and browse data on a common time scale and in a common, publication-quality format.

The SDT package of programs is written in C/C++, and runs under Sun SPARC/Solaris (SunOS 5.8 or higher), Linux (Intel, 32- or 64-bit, kernel 2.6), and MacOSX 10.5 or higher (Intel, 32-bit)

. It currently supports the display and analysis of waveform E and B field data from a variety of missions (CRRES, Polar, GEOTAIL, Cluster-2, THEMIS/ARTEMIS). It was developed from C-based software that supported the CRRES-EFI instrument (FICHE, c. 1990), and continues to support all of those missions. It also allows includes routines to allow for importation of loaded data into IDL.

The TDAS package (<http://themis.ssl.berkeley.edu/software.shtml>) runs under IDL (v.6.3 or higher, with appropriate CDF patches as needed). It currently supports the NASA THEMIS and ARTEMIS missions (both satellite particle and field and ground-based observatory data), and has includes access to a variety of geophysical indices (e.g. Kyoto Kp) and other satellite data (e.g. GOES particle and field data). It developed from software that supported the NASA FAST and WIND missions (the TPLOT package), and continues to support both those missions, as well as analysis efforts on STEREO, Polar, and Cluster-2.

Custom loading and calibration routines for the waveform, spectral, and housekeeping data products of the EFW instrument were developed from analogous routines that support the EFI instrument on THEMIS. Subsequent data reduction and analysis (coordinate transformation,

FSCM NO. <b>88898</b>	SIZE <b>A</b>	DRAWING NO. <b>7417-9129</b>	REV. <b>A</b>
SCALE	DO NOT SCALE PRINT	SHEET 63 of 78	

spin-fitting, quality determination, L1->L2 processing, VxB removal) will make use of existing procedures and scripts developed to support THEMIS-EFI. A set of IDL “crib sheets” for each of the EFW data products is under development, demonstrating the loading and basic uses and manipulations of each. These will be made available as part of the standard TDAS distribution.

In terms of standard summary plots, EFW shall produce one primary summary plot for each Observatory, which shall include panels generated from the following L2 data products: vector estimate of Eperp in geophysically-relevant inertial (e.g. GSE) or corotating (e.g. SM), both with a basic VxB subtraction (uses EMFISIS-MAG); vector estimate of dB (uses EMFISIS-MAG and model B, or an analogous EMFISIS L2 data product); estimate of SC floating potential; indication of EFW operational mode (sensor biasing table, burst trigger config, AXB illumination status, etc.); indication of EFW Burst1 collection and Burst2 collection and playback; omni-directional (TBR) energy-time spectrograms of differential energy or number flux from ECT-HOPE, ECT-MagEIS, ECT-REPT, RBSPICE, and RPS (species as relevant).

This summary plot shall include both UTC time, as well as Observatory position in a relevant geophysical coordinate system (TBD).

This summary plot shall be produced at resolutions of 24-hours (UTC 00-24); 6-hours (UTC 00-06, etc.) and some orbit-determined cadence (perigee-to-perigee, for example); less useful cadences will be weeded out downstream. Static plots shall be produced (PNG format; TBR), and made available through a suitable web-based interface (TBD).

In addition to IDL/TDAS and SDT, the use of ISTP-Compliant CDF files will also enable EFW team members and other researchers to use a variety of other analysis tools as needed or desired, as well as allow the use of AUTO PLOT templates for quick-look and browsing of data. A template that implements the standard EFW summary plot shall be provided to the Project as needed or desired.

A dictionary/glossary of all the EFW data products available in the L1 and higher ISTP-Compliant CDFs shall be generated as an aid to users of those data files, explaining the sorts of calibrations, transformations (both coordinate and frame), and other reduction algorithms (vector Eperp from  $E \cdot B = 0$ ; background subtraction on Eaxial; etc.) and made available via the EFW SOC website (URL to be included) and the RBSP SDP.

#### 4.8.4 EMFISIS

Higher level data products will be produced by the instruments teams and made available at the EMFISIS SDC and distributed from there. Codes to process data from one level to another will be maintained and run at the individual instrument teams. These codes are not intended for end-user use and will not, in general, be made available until the establishment of the final data archive. This policy is set because the EMFISIS team cannot support individual users performing re-runs of higher level processing; but as final documentation of the data these codes will enable possible further processing after mission end.

FSCM NO. <b>88898</b>	SIZE <b>A</b>	DRAWING NO. <b>7417-9129</b>	REV. <b>A</b>
SCALE	DO NOT SCALE PRINT	SHEET 64 of 78	



Data will be in the common CDF format for which many readers and utilities exist in a variety of languages (IDL, Matlab, Fortran, C, Python). We do not intend to distribute dedicated readers in these languages.

It is expected that the primary processing codes will be written in the IDL, Fortran, C, and Java languages. Additionally, EMFISIS will use Autoplot, a web-based Java utility, as a common visualization and analysis tool. This tool can run as a stand-alone plotting utility or as a plugin for IDL, and can create savesets for both Matlab and IDL.

#### 4.8.5 RBSPICE

All higher-level data products will be produced at the RBSPICE-SOC and distributed from the either the FTECS SOC website or the JHU/APL SOC website. Codes to process data from one level to another will be maintained at both locations and normally run at the FTECS SOC. The end user should have no need to run these codes. The codes will be made available on request but will not be supported outside the RBSPICE-SOC environment.

Data will be formatted as in multiple formats including CDF for data exchange between RBSP instrument teams and ASCII Comma Separated Variable (CSV) with data descriptions posted along with the data on the FTECS website and available in SPASE XML format. Dedicated readers generally become unnecessary with the ASCII (CSV) file format as the data is immediately available for use within most spreadsheet analysis tools. MIDL already has specific tools to read the CSV data and most general programming languages can easily read these file formats.

For the RBSPICE science team, the data display and analysis package “MIDL” will be provided. This is a standard analysis tool currently being used within the JHU/APL Space Department and other associated team locations and is easily distributable via the Internet and executed in a Java Virtual Machine (JVM).

MIDL also provides access to a host of other data products through its interface and can be used to display and browse data from multiple spacecraft missions. MIDL is maintained at the JHU/APL Space Department and is generally available to most scientists.

In addition to MIDL, the use of CSV formatted files and SPASE metadata will also enable RBSPICE team members and other researchers to use a variety of other analysis tools as well. These tools will be identified during Phase CD and implemented as needed.

#### 4.8.6 PSBR

All higher-level data products will be produced at the PSBR SOC and distributed from there. Codes to process data from one level to another will be maintained and run at the PSBR SOC.

FSCM NO. <b>88898</b>	SIZE <b>A</b>	DRAWING NO. <b>7417-9129</b>	REV. <b>A</b>
SCALE	DO NOT SCALE PRINT	SHEET 65 of 78	

Data will be in the common CDF format for which many readers and utilities exist in a variety of languages (IDL, Matlab, Fortran, C). There is no intention to distribute dedicated readers in these languages.

Detailed data processing will be executed on Aerospace's Technical Computing Services cluster. Processing algorithms will be prototyped in IDL or Matlab and processor intensive operations will be performed with FORTRAN or C libraries.

No RPS-specific data processing and analysis tools will be provided, only data sets. However, the RPS SOC team will work with ViRBO to facilitate access to RPS through the tools already available at the Virtual Observatories. Specifically, autoplot templates will be provided and hosted at ViRBO to enable browsing and inspection of RPS products. RPS will also participate in efforts to generate multi-sensor templates that display RBSP data together and in the larger context of geomagnetic activity.

FSCM NO. <b>88898</b>	SIZE <b>A</b>	DRAWING NO. <b>7417-9129</b>	REV. <b>A</b>
SCALE	DO NOT SCALE PRINT	SHEET 66 of 78	

## 5 DATA ARCHIVE

In the Heliophysics Data Environment, data are efficiently served through Virtual Observatories from distributed active and (long-term) resident archives. Virtual Observatories do not typically host data files. The RBSP mission requirements state that this is the instrument team's responsibility as documented in the following sections.

After a mission ends, its data will typically remain accessible through a Resident Archive that maintains easy access to data and expertise for its use. The Mission Archive Plan will show the path to creating the mission's Resident Archive(s) and the subsequent Final Archive(s).

The instrument teams plan on providing their data files to SPDF, which will act as the resident archive. CDAWeb will provide a mechanism to search and retrieve RBSP data files and provide some capability to plot data.

### 5.1 STORAGE AND ARCHIVE STRATEGY

#### 5.1.1 ECT

Level 0 data received by the ECT-SOC will be backed up automatically at LANL. Since these data files will also be archived by the MOC, this will provide a redundant archive.

Level 1 – 4 data will have two forms of archive at LANL:

- A “live” archive through the existing large Network Applications disk farms that maintain built in redundancy, un-delete support and provide for a better than 99% up-time.
- A mass storage solution provided by LANL computer support group that provides adequate storage. Data will be incrementally backed up to this mass storage device on a daily basis. This system is currently available at LANL, and will be available until well after the RBSP prime (and possible extended) mission phases.
- Backup of ECT-SDC data onto removable media is not required.

As data are reprocessed this will be documented through file version numbers. The “live” archive will maintain the latest file version, which the mass store will retain all versions unless manually deleted.

The ECT team will implement the RBSP Mission Archive Plan once it becomes available and within the constraints of the archival forms available at LANL. It is envisaged that LANL will be able to support NASA's “resident archive” model for post-mission access to the ECT data by providing data to SPDF

#### 5.1.2 EFW

Level 0 data received by the EFW-SOC will be backed up automatically at UCB SSL. These data files are compatible with the existing near real-time and stored data processing tool

FSCM NO. <b>88898</b>	SIZE <b>A</b>	DRAWING NO. <b>7417-9129</b>	REV. <b>A</b>
SCALE	DO NOT SCALE PRINT	SHEET 67 of 78	

available at UCB SSL to the EFW team. Since these data files will also be archived by the MOC, this will provide a redundant archive.

Level 1-4 data will similarly be backed up at UCB SSL.

As data are reprocessed this will be documented through the usual CDF file version numbers mechanism.

The EFW team will implement the RBSP Mission Archive Plan once it becomes available and within the constraints of the archival forms available at UCB SSL. It is envisaged that UCB SSL will be able to support NASA's "resident archive" model for post-mission access to the EFW data.

### 5.1.3 EMFISIS

Level 0 data received by the EMFISIS SOC-SDC will be backed up automatically at UI on a regular basis. Since these data files will also be archived by the MOC, this will provide a redundant archive.

Level 1 – 4 data will have two forms of archive at UI:

- An online archive that will provide continuous access to both EMFISIS science team members and public, external access. This archive will be achieved through usage of large capacity disk drives (for rapid access) and will be backed up regularly.
- A permanent archive retained at UI on an appropriate media such as DVD-ROM or Cd-ROM if DVD-ROM is not sufficiently stable. As the technology for such archiving evolves, the EMFISIS team will select the most appropriate media. Two copies of this archive will be made, with one stored off-site.

As data are reprocessed this will be documented through file version numbers. The naming convention for data files will include version numbers to allow easy identification of the most current version of a given data product.

For the long term, EMFISIS intends to support the RBSP mission archive plan once it becomes available and can be implemented within the constraints of the archival forms available at UI.

### 5.1.4 RBSPICE

Level 0 data received by the RBSPICE SOC will be backed up automatically at FTECS and JHU/APL. Since these data files will also be archived by the MOC, this will provide a redundant archive.

Higher level data will have two forms of archive at FTECS and at JHU/APL.

A SQL server database will provide access to any portion of any of the Level 1 and higher data products and will be automatically replicated to the SQL servers at JHU/APL.

FSCM NO. <b>88898</b>	SIZE <b>A</b>	DRAWING NO. <b>7417-9129</b>	REV. <b>A</b>
SCALE	DO NOT SCALE PRINT	SHEET 68 of 78	

- All data files including the flat CSV files made available to the general public via FTP and HTTP interfaces will exist on RAID V terabyte data stores and will automatically be backed up each day onto a separate RAID V terabyte data backup units allowing for fast recovery in the event of system failure.
- No RBSPICE specific backup on external media (e.g. tape, DVD, CD) is envisaged.

As data are reprocessed, this will be documented through file version numbers. The SQL server database systems will maintain the latest data versions and the terabyte mass storage system will retain all versions unless manually deleted.

The RBSPICE team will implement the RBSP Mission Archive Plan once it becomes available and within the constraints of the archival forms available at FTECS. It is expected that FTECS will be the RBSPICE Resident Archive for post mission data access in support of NASA's "resident archive" program.

### 5.1.5 PSBR

In accordance with the NASA-NRO MOA, NASA will provide for the long-term archiving of the RPS data. The RPS SOC team will work with NASA personnel at SPDF to transfer the RPS data to their long-term archive.

A separate Mission Archive Plan from the RBSP Mission Archive Plan for the RPS data will be prepared by the end of the nominal mission (checkout plus 2 years). In that plan, accommodation for long-term archiving of the RPS data will be addressed as well as integration into the national space science information infrastructure at that time.

FSCM NO. <b>88898</b>	SIZE <b>A</b>	DRAWING NO. <b>7417-9129</b>	REV. <b>A</b>
SCALE	DO NOT SCALE PRINT	SHEET 69 of 78	

## 6 DATA AVAILABILITY

NASA has an open data policy that high-quality, high-resolution data, as defined by the mission goals, will be made publicly available as soon as practical. The individual instrument teams are responsible for making their data products publicly available as described in the sections below and are working with various Virtual Observatories including VirBO to promote the distribution of their data.

### 6.1 DATA ACCESS POLICY

#### 6.1.1 ECT

All data from level 2 data products and above will be publicly available, together with any other ancillary data available at the time (LANL GEO, GPS, NOAA, etc). These data will be served from the ECT-SDC website and can be accessed by ftp or http-clients. CDF files will also be provided to SPDF for inclusion in CDAWeb.

Users who elect to use the PAPCO package will further be able to download the data and access it remotely through the PAPCO tool.

All ECT data will be incorporated into the Virtual Radiation Belt Observatory (VirBO) for further dissemination.

#### 6.1.2 EFW

All data from level 2 data products and above will be publicly available, together with any other ancillary data available at the time. These data will be served from the EFW-SDC website and can be accessed by ftp or http-clients. CDF files will also be provided to SPDF for inclusion in CDAWeb.

Users who elect to use the TDAS-derived analysis package will further be able to download the data and access it remotely through that package.

#### 6.1.3 EMFISIS

All data from level 2 data products and above will be publicly available, together with any other ancillary data such as spacecraft ephemeris data. These data will be served from the EMFISIS SDC website and can be accessed by ftp or http-clients. CDF files will also be provided to SPDF for inclusion in CDAWeb.

All EMFISIS data will be made available for incorporation into the Virtual Radiation Belt Observatory (VirBO) for further dissemination.

FSCM NO. <b>88898</b>	SIZE <b>A</b>	DRAWING NO. <b>7417-9129</b>	REV. <b>A</b>
SCALE	DO NOT SCALE PRINT	SHEET 70 of 78	

#### 6.1.4 RBSPICE

All data from level 1 data products and above will be publicly available, together with any other ancillary data available at the time. These data products will be served from the FTECS public website and can be accessed by ftp or http-clients as well as a proposed Web Services Interface using SOAP and SPASE XML. CDF files will also be provided to SPDF for inclusion in CDAWeb.

All RBSPICE data will be described and cataloged via SPASE XML metadata for inclusion in the Virtual Radioation Belt Observatory (VirBO). The SPASE metadata will become searchable through VirBO with the search results pointing to the data located within the FTECS publicly accessible RBSPICE web site.

#### 6.1.5 PSBR

All PSBR data, levels 1 through 4, and supporting files will be publicly available. These data will be served from the PSBR web site and via anonymous FTP. CDF files will also be provided to SPDF for inclusion in CDAWeb.

The scientific community will have access to the RPS data either through the FTP site or through the Virtual Observatory system. The RPS SOC will coordinate with VirBO or other VOs to facilitate access to the RPS data by Virtual Observatory users.

### 6.2 DATA RELEASE SCHEDULE

#### 6.2.1 ECT

The following availability schedule applies once routine data processing is fully automated:

Level 1 data products will not be made publically available as they are not scientifically useful and will be superseded by Level 2

Level 2 data products will be publicly available within 2 weeks of receipt of the L0 telemetry and supporting ancillary files.

Level 3 data products will be publicly available within 2 months of receipt of the L0 telemetry and supporting ancillary files.

Level 4 data products will be publicly available within 12 months of receipt of the L0 telemetry and supporting ancillary files.

Reprocessing of data will be automatically triggered by newer versions of the relevant input files for a given level of processing becoming available. Reprocessing will generally be run daily. Thus if a new magnetic field file, Level 2 file or calibration file becomes available, reprocessing will be triggered with a maximum of one-day latency.

#### 6.2.2 EFW

FSCM NO. <b>88898</b>	SIZE <b>A</b>	DRAWING NO. <b>7417-9129</b>	REV. <b>A</b>
SCALE	DO NOT SCALE PRINT	SHEET 71 of 78	

The following availability schedule applies once routine data processing is fully automated:

Level 1 data products will not be made publically available as they are not scientifically useful and will be superseded by Level 2

Level 2 data products will be publicly available within 1 week of receipt of the L0 telemetry and supporting ancillary files.

Level 3 data products will be publicly available within 1 month of receipt of the L0 telemetry and supporting ancillary files.

Level 4 data products will be publicly available within 12 months of receipt of the L0 telemetry and supporting ancillary files.

Reprocessing of data will be automatically triggered by newer versions of the relevant input files for a given level of processing becoming available. Reprocessing will generally be run daily. Thus if a new magnetic field file, Level 2 file or calibration file becomes available, reprocessing will be triggered with a maximum of one-day latency

### 6.2.3 EMFISIS

The following availability schedule applies once routine data processing is fully automated:

Level 1 data products will be publicly available within 8 days of receipt of the L0 telemetry and supporting ancillary files.

Level 2 data products will be publicly available within 60 days of receipt of the L0 telemetry and supporting ancillary files (14 days for the MAG)

Level 3 data products will be publicly available within 4 months of receipt of the L0 telemetry and supporting ancillary files.

Level 4 data products will be publicly available within 12 months of receipt of the L0 telemetry and supporting ancillary files.

### 6.2.4 RBSPICE

The following availability schedule applies once routine data processing is fully automated:

Level 1 data products will be publicly available within 14 days of receipt of the L0 telemetry and supporting ancillary files.

Level 2 data products will be publicly available within 1 month of receipt of the L0 telemetry and supporting ancillary files.

Level 3 data products will be publicly available within 3 months of receipt of the L0 telemetry and supporting ancillary files.

FSCM NO. <b>88898</b>	SIZE <b>A</b>	DRAWING NO. <b>7417-9129</b>	REV. <b>A</b>
SCALE	DO NOT SCALE PRINT	SHEET 72 of 78	



Level 4 data products will be publicly available within 1 year of receipt of the L0 telemetry and supporting ancillary files and are generated for targeted ring current science and not for all times of data collection.

Reprocessing of data will be automatically triggered by newer versions of the relevant input files for a given level of processing becoming available. Reprocessing will generally be run daily. Thus if a new data file, magnetic field file, magnetic field calibration file, Level 2 file or calibration file becomes available, reprocessing will be triggered with a maximum of three day latency.

### 6.2.5 PSBR

An initial set of support files (calibration, metadata, source code, logs) will be placed on the Website prior to the launch of RBSP. Updated support files and RPS data files will be posted to the Website as available.

The following availability schedule applies once routine data processing is fully automated:

Level 1 data products will be posted to the Website within 3 working days of receipt of L0 from the MOC.

Level 2 data products will be posted to the Website within 5 working days of receipt of raw data and magnetometer, ephemeris, attitude, and mission time offset data from the MOC.

Level 3 data products will be posted to the Website within 7 working days of receipt of raw data and magnetometer, ephemeris, attitude, and mission time offset data from the MOC.

Level 4 data products will be posted to the Website within 9 working days of receipt of raw data and magnetometer, ephemeris, attitude, and mission time offset data from the MOC

## 6.3 DATA CATALOGS

The ISTP compliant CDF files produced by the instrument teams will be used as a basis to generate SPASE compliant meta-data. ViRBO will work with SPDF and the instrument teams to produce SPASE meta-data files and validate them.

### 6.3.1 ECT

### 6.3.2 THE CATALOG FUNCTION IS TO BE HANDLED BY THE VIRTUAL RADIATION BELT OBSERVATORY (VIRBO). EFW

All EFW data will be described and cataloged via SPASE XML metadata into the RBSP project-defined VO such as the Virtual Radiation Belt Observatory (ViRBO). The SPASE metadata will become searchable thru the VO with the search results pointing to the data located within the UCB publicly accessible EFW-SDC web site. If for some reason the VO service is not available, then on-line, ASCII text catalogs of data availability and instrument configuration will be made available through a simple web-based interface hosted at the EFW-SDC.

FSCM NO. <b>88898</b>	SIZE <b>A</b>	DRAWING NO. <b>7417-9129</b>	REV. <b>A</b>
SCALE	DO NOT SCALE PRINT	SHEET 73 of 78	

### 6.3.3 EMFISIS

The EMFISIS SDCC will maintain an on-line, ASCII text catalog giving relevant parameters such as data quality, missing data, and availability of burst data.

### 6.3.4 RBSPICE

The RBSPICE data catalogue will be presented to the general public in a variety of different ways.

- **FTP and Web Interface**  
The list of data products will be documented in the RBSPICE Data Analysis Handbook available on the FTECS web site and the general catalogue of individual data files will be available via standard FTP/HTTP queries of the FTECS HTTP/FTP site. The CDF and ASCII (CSV) file formats will be directly available via this site as well as SPASE XML metadata file descriptions.
- **Web Services Interface**  
Search and query commands will be available within the FTECS RBSPICE Web Services interface providing the ability for automated computer systems to derive a full catalogue of RBSPICE data products and to identify data availability. This interface will provide simple protocols for access to the RBSPICE data via Simple Object Access Protocol statements retrieving any available data at whatever granular level is desired by the software. It is proposed also that this interface will also make data averaging functionality available as a regular portion of the SOAP query.
- **Publication of RBSPICE meta-data to allow ingestion of RBSPICE data by Virtual Observatories**
  - **RBSPICE SPASE Data Model Publication**  
An RBSPICE SPASE data model will be produced providing the ability of VO middleware software to catalogue and characterize the RBSPICE Web Services interface and access to the RBSPICE Data via this interface.
  - **SPASE Data Product Descriptions**  
The RBSPICE data products will have general SPASE metadata descriptions of each RBSPICE data product created and published to whichever Virtual Observatory that the RBSP project determines, such as the Virtual Radiation Belt Observatory (ViRBO).
  - **SPASE Granular Level Data Product Descriptions**  
Granular level SPASE data descriptions will be produced for all data files that are available from the FTECS Web and FTP interface. These granular descriptions will provide all required and whatever supplementary data is deemed relevant to the RBSPICE data.

FSCM NO. <b>88898</b>	SIZE <b>A</b>	DRAWING NO. <b>7417-9129</b>	REV. <b>A</b>
SCALE	DO NOT SCALE PRINT	SHEET 74 of 78	

### 6.3.5 PSBR

The RPS SOC will not provide a data catalogue (as defined by SPASE). However the RPS SOC team will work with ViRBO or other VOs to integrate the RPS data set into the Virtual Observatory catalogues.

FSCM NO. <b>88898</b>	SIZE <b>A</b>	DRAWING NO. <b>7417-9129</b>	REV. <b>A</b>
SCALE	DO NOT SCALE PRINT	SHEET 75 of 78	

## APPENDIX A: ACRONYMS

ASCII	American Standard Code for Information Exchange
CDAWEB	Coordinated Data Analysis Web
CDF	Common Data Format
CDPU	Central Data Processing Unit
CD-ROM	Compact Disc Read Only Memory
CONOPS	Concept of Operations
COSPAR	Committee On Space Research
CSOC	Command Science Operation Center
CSV	Comma Separated Value
CTG	Command Telemetry and GSE
DVD-ROM	Digital Versatile Disc Read Only Memory
ECT	Energetic Particle Composition and Thermal Plasma Investigation
EFW	Electric Field and Waves Instrument
EM	Engineering Model
EMFISIS	Electric and Magnetic Field Instrument Suite and Integrated Science Investigation
FTECS	Fundamental Technologies, LLC in Lawrence, KS
FTP	File Transfer Protocol
GSE	Ground Support Equipment
GSEOS	Ground Support Equipment Operating System
GSFC	Goddard Space Flight Center
HOPE	Helium-Oxygen-Proton-Electron Spectrometer Instrument
HTTP	Hypertext Transfer Protocol
I&T	Integration & Test
ICD	Interface Control Document
IDL	Interactive Data Language
ISTP	International Solar Terrestrial Physics
JHU/APL	Johns Hopkins University Applied Physics Laboratory

FSCM NO. <b>88898</b>	SIZE <b>A</b>	DRAWING NO. <b>7417-9129</b>	REV. <b>A</b>
SCALE	DO NOT SCALE PRINT		SHEET <b>76</b> of <b>78</b>

LANL	Los Alamos National Laboratory
LWS	Living With a Star
MagEIS	Magnetic Electron Ion Spectrometer
MET	Mission Elapsed Time
MIDL	Mission Independent Data Level
MOA	Memorandum of Understanding
MOC	Mission Operation Center
MRD	Mission Requirements Document
NASA	National Aeronautics and Space Administration
NRO	National Reconnaissance Office
PAPCO	Panel Plot Composer
SDMP	Science Data Management Plan
PRBEM	Panel on Radiation Belt Environment Modeling
PSBR	Proton Spectrometer Belt Research
RAID	Redundant Array of Inexpensive Disks
RBSP	Radiation Belt Storm Probes
RBSPICE	Radiation Belt Storm Probes Ion Composition Experiment
REPT	Relativistic Electron Proton Telescope Instrument
RHESSI	Reuven Ramaty High Energy Solar Spectroscopic Imager
RPS	Relativistic Proton Spectrometer Instrument
SASOC	Science Analysis Science Operation Center
SDC	Science Data Center
SDT	Science Data Tool
SSH	Secure SHell
SOAP	Simple Object Access Protocol
SOC	Science Operation Center
SOH	State Of Health
SPASE	Space Physics Archive Search and Extract
SQL	Structured Query Language

FSCM NO. <b>88898</b>	SIZE <b>A</b>	DRAWING NO. <b>7417-9129</b>	REV. <b>A</b>
SCALE	DO NOT SCALE PRINT	SHEET 77 of 78	

SWG Science Working Group  
 TBD To Be Determined  
 TCP/IP Transmission Control Protocol/Internet Protocol  
 TDAS THEMIS Data Analysis Tool  
 THEMIS Time History of Events and Macroscale Interactions during Substorms  
 UCB SSL University of California, Berkeley Space Sciences Laboratory  
 UI University of Iowa  
 UNH University of New Hampshire  
 UTC Universal Time Coordinated  
 ViRBO Virtual Radiation Belt Observatory  
 VNC Virtual Network Connection  
 VO Virtual Observatory  
 XML Extensible Markup Language

FSCM NO. <b>88898</b>	SIZE <b>A</b>	DRAWING NO. <b>7417-9129</b>	REV. <b>A</b>
SCALE	DO NOT SCALE PRINT		SHEET <b>78</b> of <b>78</b>