

OBSERVATORY OUTLINE
01 SEP 2015

- Location:** 29° 50' 13" N 29.8369° N EL89qu
82° 37' 17" W 82.6214° W
53 ft (16 m) MSL
- TFD Array:** Two square arrays on a NS line, eight 30-foot TFD elements, beam steering in 5° increments NS and 15° increments EW.
16 MHz HPBW at zenith: 18° NS x 40° EW
20 MHz HPBW at zenith: 15° NS x 35° EW, $D \approx 14$ dBic
24 MHz HPBW at zenith: 12° NS x 30° EW
32 MHz HPBW at zenith: 8° NS x 20° EW
- Receivers:** 1 x Dual Polarization Spectrograph (DPS)
24 x 7 x 365 unattended operation
16–32 MHz, simultaneous (correlated) RCP and LCP
300 channels per polarization (600 total)
Swept frequency, selectable 7.5, 15, 30, 60 kHz pre-detection BW
~ 6.7 sweeps/sec, integration time = 500 μ s per sample
Frequency resolution = 53 kHz, $\Delta t = 150$ ms
- 1 x Tunable Wideband Receiver (TWB) Mark III
Attended operation only
Tunable from 16 to 32 MHz, RCP or LCP
2 MHz IF BW direct to high speed digitizer
FFT post-processing, RBW = 4.88 kHz, $\Delta t = 205$ μ s
- 1 x FS-200B radio spectrograph
24 x 7 x 365 unattended operation
16–26 MHz, RCP or LCP, 200 channels
Swept frequency, 30 kHz pre-detection BW
~ 10 sweeps/sec, integration time = 500 μ s per sample
Frequency resolution = 53 kHz, $\Delta t = 150$ ms
- 2 x Radio Jove receivers
24 x 7 x 365 unattended operation
~ 20.1 MHz, uncorrelated RCP and LCP
7 kHz RF BW folded via direct conversion into
a baseband 3.5 kHz pre-detection audio BW
Integration time = 100 ms per sample

- Sensitivity:** Formal sensitivity calculations and measurements have not been made. A rough estimate considering only the number of dipoles is a 20 MHz on-axis and at zenith 3σ sensitivity on the order of 100 kJy. In the upper HF band, system noise is dominated by the galactic background emission. All receivers presently in use have noise figures between 6 and 8 dB, making their internal noise of little concern given the modest losses between the TFD array and the receivers.
- Timing:** All radio telescope data collection systems use a PC's internal clock to apply timestamps to the data. Each PC runs a service, Meinberg NTP daemon, to keep its system clock within a few milliseconds of UTC using Network Time Protocol (NTP). Future work includes upgrading to a GPS-based hardware and software system to keep the system clocks and/or spectrograph frequency sweeps disciplined within a hundred nanoseconds of UTC.
- Calibration:** All radio telescope systems are calibrated in terms of antenna temperature using a noise source of known temperature calibrated against a 5722 noise diode. An automatic calibrator runs a step calibration on all receivers at 2350 UTC every day. The step cal runs in 17 steps of 5 seconds each separated by 3 dB, ranging from 1.1 kK to 53 MK equivalent antenna temperature.
- Computers:** Three identical PCs are used to record data from the receivers. Each has a 2.4 GHz AMD Opteron dual-core processor, 4 GB RAM, and a 1 TB hard drive. All run Windows XP SP3. All are connected to the observatory LAN.
- Internet:** The observatory has internet access via a 6 Mbps DSL connection. This connection allows the Radio Sky Pipe (RSS) and Radio Sky Spectrograph (RSS) software to serve data to interested remote observers.
- Power:** The receivers, computers, and network hardware are fed by three 1.5 kVA battery backup units providing at least 15 minutes of power if the AC mains fail.
- Operations:** Several radio telescopes operate all day, every day (see "Receivers" above). Useful Jupiter observations are made any time Jupiter is within 3.5 hours of transit.

Juno Support

AJ4CO Observatory (Dave Typinski) will support the Juno ground-based coordinated observations campaign with the following instruments.

Dual Polarization Spectrograph (low resolution)

The DPS will continue to make continuous Jupiter observations. The data will be made publicly available using the VESPA archive, with the conversion to CDF format being done on the VESPA server. Data will be available within 24 hours after the end of each day's observing run.

Tunable Wideband Receiver (high resolution)

The TWB will be operated manually as needed to support the ground-based coordinated observations campaign. Data will be available on an as-requested basis due to the size of the data files produced. Raw time-series waveform data will be available within 24 hours. Processed data (time/freq dynamic spectra) will be available after several days processing time.

North →

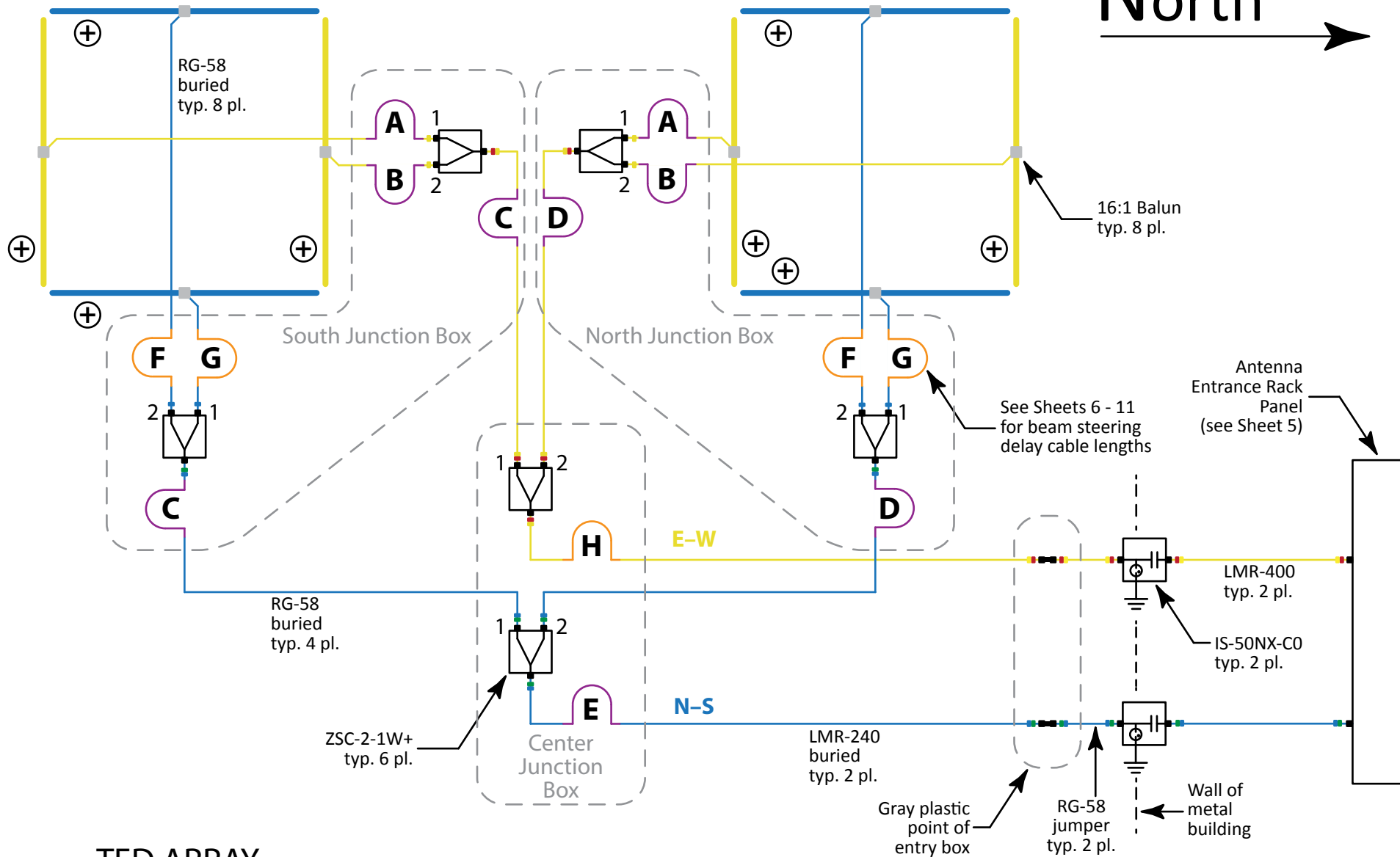

TFD ARRAY CONFIGURATION C CP MODE

See Sheet 5 for XY to CP 90° Hybrid

30' folded dipoles, top wire 9'2" height,
8" wire spacing, 32' element spacing,
800 Ω termination resistors, 16:1 baluns.

See Sheet 4 for feed system measured losses.



AJ4CO Observatory Diagram

SIZE A	DATE 28 MAR 2015	PART NUMBER N/A	REV
SCALE NONE	DRAWN BY DAVE TYPINSKI	SHEET 1 OF 11	

North 

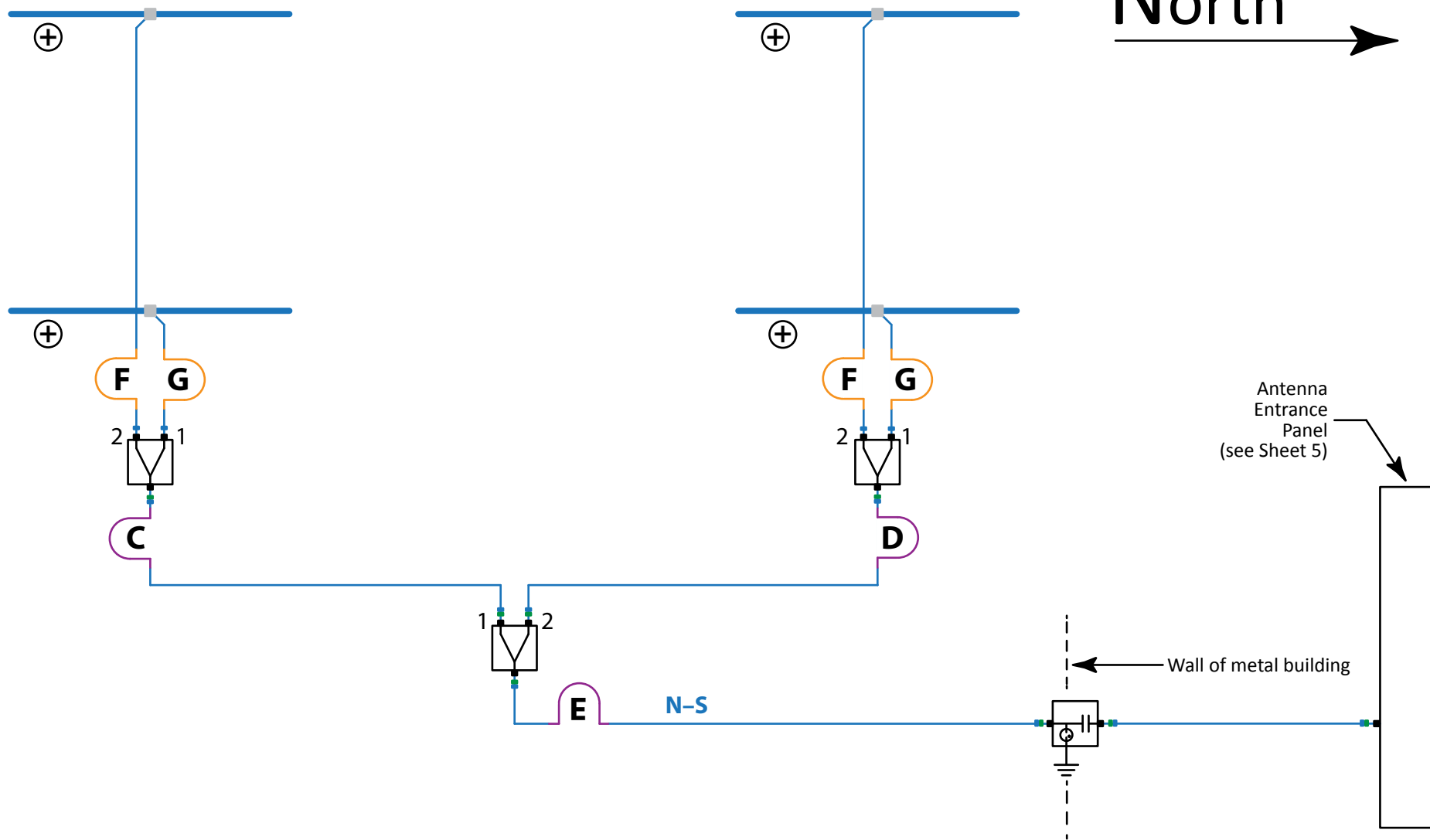

Antenna Entrance Panel
(see Sheet 5)

Wall of metal building

North-South Elements Only

		AJ4CO Observatory Diagram		
		SIZE A	DATE 28 MAR 2015	PART NUMBER N/A
SCALE NONE		DRAWN BY DAVE TYPINSKI		SHEET 2 OF 11

North →

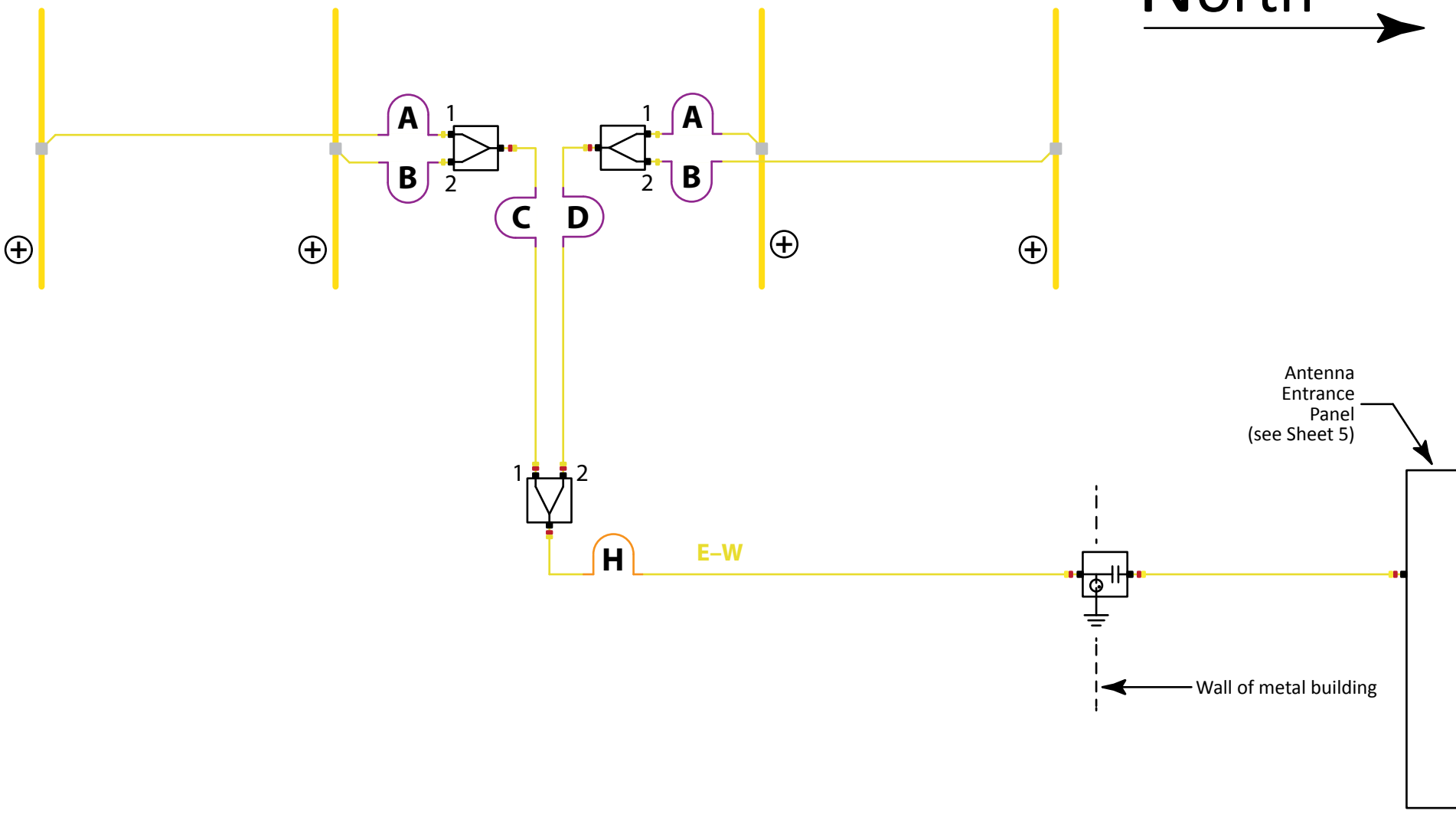

Antenna Entrance Panel (see Sheet 5)

Wall of metal building

East-West Elements Only

		AJ4CO Observatory Diagram			
		SIZE A	DATE 28 MAR 2015	PART NUMBER N/A	REV
SCALE NONE		DRAWN BY DAVE TYPINSKI		SHEET 3 OF 11	

TFD Array Feed System Losses

Feed line loss sweeps performed 28 Mar 2015

Device sweeps performed 11 Aug 2013

	Rack panel to gray point of entry box LMR-400	Gray box to center J-box LMR-240	Center J-box to outer J-box RG-58	Outer J-box to element balun RG-58	Synergy DQK-701B 90° Hybrid (one)	Mini-Circuits ZSC-2-1W+ Combiners (two)	AJ4CO BALUN16-1A 16:1 Balun (one)	Loss Between Element Feed Points and Hybrid Outputs (dB)
	One Way	One Way	One Way	One Way	Loss	Loss	Loss	
Freq (MHz)	Loss (dB)	Loss (dB)	Loss (dB)	Loss (dB)	Loss (dB)	Loss (dB)	Loss (dB)	Loss (dB)
16	-0.99	-0.94	-0.75	-0.33	-0.21	-0.40	-0.52	-4.1
18	-1.04	-0.99	-0.79	-0.35	-0.26	-0.41	-0.54	-4.4
20	-1.09	-1.03	-0.84	-0.37	-0.29	-0.42	-0.55	-4.6
22	-1.15	-1.07	-0.89	-0.39	-0.32	-0.43	-0.57	-4.8
24	-1.20	-1.11	-0.93	-0.40	-0.34	-0.44	-0.58	-5.0
26	-1.24	-1.16	-0.97	-0.42	-0.34	-0.45	-0.59	-5.2
28	-1.28	-1.20	-1.00	-0.45	-0.32	-0.47	-0.60	-5.3
30	-1.32	-1.23	-1.04	-0.46	-0.30	-0.49	-0.61	-5.5
32	-1.36	-1.27	-1.09	-0.46	-0.27	-0.50	-0.62	-5.6



AJ4CO Observatory Diagram

SIZE	DATE	PART NUMBER	REV
A	28 MAR 2015	N/A	
SCALE	NONE	DRAWN BY	SHEET
		DAVE TYPINSKI	4 OF 11

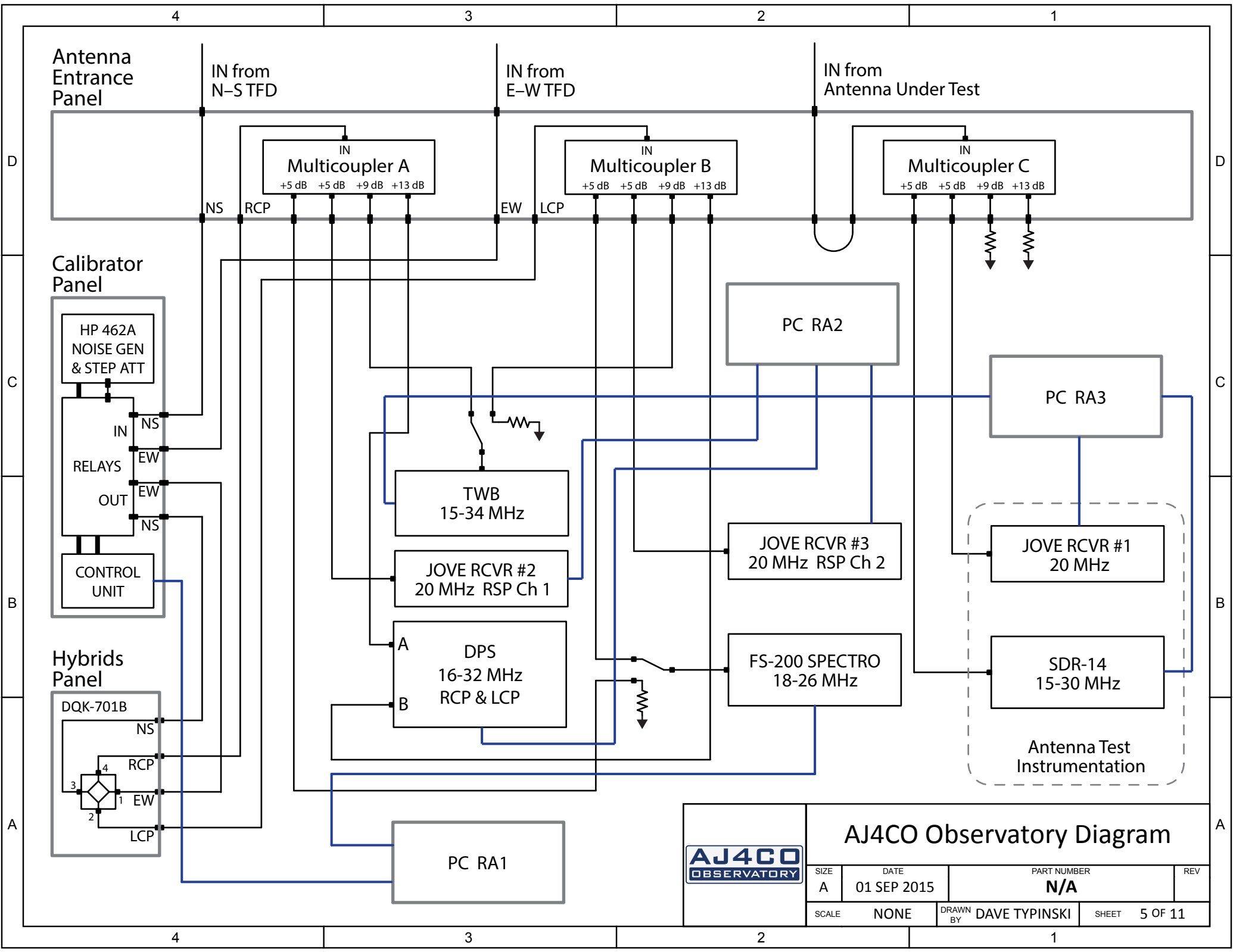

AJ4CO Observatory Diagram



SIZE A	DATE 01 SEP 2015	PART NUMBER N/A	REV
SCALE NONE	DRAWN BY DAVE TYPINSKI	SHEET 5 OF 11	

Automatic Calibrator Temperatures – HP 462A, S/N 421-00472 + Kay 4450, S/N 9-5

T₀ (K)	290	
Noise Source Temperature (MK)	46.1	
Splitter Loss @ 20 MHz (dB)	0.2	
Effective Noise Source Temp (MK)	22.1	(after splitter)
Antenna Feed Loss @ 20 MHz (dB)	4.3	
DPS Noise Figure @ 20 MHz (dB)	3.4	= 344 K @ HYBRID INPUTS

Reference Plane: between entrance panel TFD array feeds and hybrid ring inputs.

Nom. Att. (dB)	Meas. Att. (dB)	MC Input Temp. (K)	Equivalent Antenna Temp. (K)	Nom. Att. (dB)	Meas. Att. (dB)	MC Input Temp. (K)	Equivalent Antenna Temp. (K)
0.00	0.56	19,400,000	52,200,000	0.00	0.56	19,400,000	52,200,000
1.00	1.52	15,500,000	41,700,000	3.00	3.43	10,000,000	26,900,000
2.00	2.56	12,200,000	32,800,000	6.00	6.47	4,970,000	13,400,000
4.00	4.57	7,700,000	20,700,000	9.00	9.45	2,500,000	6,730,000
8.00	8.55	3,080,000	8,290,000	12.00	12.58	1,220,000	3,280,000
16.00	16.58	486,000	1,310,000	15.00	15.48	625,000	1,680,000
32.00	32.50	13,000	33,600	18.00	18.55	309,000	830,000
64.00	64.65	642	310	21.00	21.50	157,000	421,000
				24.00	24.55	78,000	209,000
				27.00	27.51	39,800	106,000
				30.00	30.58	19,900	52,100
				33.00	33.49	10,500	26,800
				36.00	36.54	5,530	13,500
				39.00	39.55	3,080	6,870
				42.00	42.55	1,860	3,590
				45.00	45.59	1,240	1,920
				48.00	48.55	943	1,120

	<h2>AJ4CO Observatory Diagram</h2>			
	SIZE A	DATE 01 OCT 2014	PART NUMBER N/A	REV
	SCALE NONE	DRAWN BY DAVE TYPINSKI	SHEET 6 OF 12	

TFD Array Beam Steering

Time Delay Cable VoP: **66%** ray elements N-S baseline spacing (feet): **32**
 Array elements E-W baseline spacing (feet): **32**

N-S Offset (degrees)	E-W Offset (degrees)	Delay Cable Lengths (feet & inches)					AZ (degrees)	EL (degrees)
		A (S) / B (N)	C (S) / D (N)	E	F (W) / G (E)	H		
20 N	60 E	7' 2-3/4"	14' 5-1/4"	3' 7-1/4"	18' 3-1/2"	9' 1-3/4"	78	29
20 N	45 E	7' 2-3/4"	14' 5-1/4"	3' 7-1/4"	14' 11-1/4"	7' 5-1/2"	70	43
20 N	30 E	7' 2-3/4"	14' 5-1/4"	3' 7-1/4"	10' 6-3/4"	5' 3-1/4"	58	56
20 N	15 E	7' 2-3/4"	14' 5-1/4"	3' 7-1/4"	5' 5-1/2"	2' 8-3/4"	36	66
20 N	0	7' 2-3/4"	14' 5-1/4"	3' 7-1/4"	0"	0"	0	70
20 N	15 W	7' 2-3/4"	14' 5-1/4"	3' 7-1/4"	5' 5-1/2"	2' 8-3/4"	324	66
20 N	30 W	7' 2-3/4"	14' 5-1/4"	3' 7-1/4"	10' 6-3/4"	5' 3-1/4"	302	56
20 N	45 W	7' 2-3/4"	14' 5-1/4"	3' 7-1/4"	14' 11-1/4"	7' 5-1/2"	290	43
20 N	60 W	7' 2-3/4"	14' 5-1/4"	3' 7-1/4"	18' 3-1/2"	9' 1-3/4"	282	29
15 N	60 E	5' 5-1/2"	10' 11-1/4"	2' 8-3/4"	18' 3-1/2"	9' 1-3/4"	81	30
15 N	45 E	5' 5-1/2"	10' 11-1/4"	2' 8-3/4"	14' 11-1/4"	7' 5-1/2"	75	44
15 N	30 E	5' 5-1/2"	10' 11-1/4"	2' 8-3/4"	10' 6-3/4"	5' 3-1/4"	65	58
15 N	15 E	5' 5-1/2"	10' 11-1/4"	2' 8-3/4"	5' 5-1/2"	2' 8-3/4"	45	69
15 N	0	5' 5-1/2"	10' 11-1/4"	2' 8-3/4"	0"	0"	360	75
15 N	15 W	5' 5-1/2"	10' 11-1/4"	2' 8-3/4"	5' 5-1/2"	2' 8-3/4"	315	69
15 N	30 W	5' 5-1/2"	10' 11-1/4"	2' 8-3/4"	10' 6-3/4"	5' 3-1/4"	295	58
15 N	45 W	5' 5-1/2"	10' 11-1/4"	2' 8-3/4"	14' 11-1/4"	7' 5-1/2"	285	44
15 N	60 W	5' 5-1/2"	10' 11-1/4"	2' 8-3/4"	18' 3-1/2"	9' 1-3/4"	279	30
10 N	60 E	3' 8"	7' 4"	1' 10"	18' 3-1/2"	9' 1-3/4"	84	30
10 N	45 E	3' 8"	7' 4"	1' 10"	14' 11-1/4"	7' 5-1/2"	80	45
10 N	30 E	3' 8"	7' 4"	1' 10"	10' 6-3/4"	5' 3-1/4"	73	59
10 N	15 E	3' 8"	7' 4"	1' 10"	5' 5-1/2"	2' 8-3/4"	57	72
10 N	0	3' 8"	7' 4"	1' 10"	0"	0"	360	80
10 N	15 W	3' 8"	7' 4"	1' 10"	5' 5-1/2"	2' 8-3/4"	303	72
10 N	30 W	3' 8"	7' 4"	1' 10"	10' 6-3/4"	5' 3-1/4"	287	59
10 N	45 W	3' 8"	7' 4"	1' 10"	14' 11-1/4"	7' 5-1/2"	280	45
10 N	60 W	3' 8"	7' 4"	1' 10"	18' 3-1/2"	9' 1-3/4"	276	30



AJ4CO Observatory Diagram

SIZE A	DATE 01 OCT 2014	PART NUMBER N/A	REV
SCALE NONE	DRAWN BY DAVE TYPINSKI	SHEET 7 OF 12	

TFD Array Beam Steering

Time Delay Cable VoP: 66% **Array elements N-S baseline spacing (feet): 32**
Array elements E-W baseline spacing (feet): 32

N-S Offset (degrees)	E-W Offset (degrees)	Delay Cable Lengths (feet & inches)					AZ (degrees)	EL (degrees)
		A (S) / B (N)	C (S) / D (N)	E	F (W) / G (E)	H		
5 N	60 E	1' 10"	3' 8-1/4"	11"	18' 3-1/2"	9' 1-3/4"	87	30
5 N	45 E	1' 10"	3' 8-1/4"	11"	14' 11-1/4"	7' 5-1/2"	85	45
5 N	30 E	1' 10"	3' 8-1/4"	11"	10' 6-3/4"	5' 3-1/4"	81	60
5 N	15 E	1' 10"	3' 8-1/4"	11"	5' 5-1/2"	2' 8-3/4"	72	74
5 N	0	1' 10"	3' 8-1/4"	11"	0"	0"	360	85
5 N	15 W	1' 10"	3' 8-1/4"	11"	5' 5-1/2"	2' 8-3/4"	288	74
5 N	30 W	1' 10"	3' 8-1/4"	11"	10' 6-3/4"	5' 3-1/4"	279	60
5 N	45 W	1' 10"	3' 8-1/4"	11"	14' 11-1/4"	7' 5-1/2"	275	45
5 N	60 W	1' 10"	3' 8-1/4"	11"	18' 3-1/2"	9' 1-3/4"	273	30
<hr/>								
0	60 E	0"	0"	0"	18' 3-1/2"	9' 1-3/4"	90	30
0	45 E	0"	0"	0"	14' 11-1/4"	7' 5-1/2"	90	45
0	30 E	0"	0"	0"	10' 6-3/4"	5' 3-1/4"	90	60
0	15 E	0"	0"	0"	5' 5-1/2"	2' 8-3/4"	90	75
0	0	0"	0"	0"	0"	0"	180	90
0	15 W	0"	0"	0"	5' 5-1/2"	2' 8-3/4"	270	75
0	30 W	0"	0"	0"	10' 6-3/4"	5' 3-1/4"	270	60
0	45 W	0"	0"	0"	14' 11-1/4"	7' 5-1/2"	270	45
0	60 W	0"	0"	0"	18' 3-1/2"	9' 1-3/4"	270	30
<hr/>								
5 S	60 E	1' 10"	3' 8-1/4"	11"	18' 3-1/2"	9' 1-3/4"	93	30
5 S	45 E	1' 10"	3' 8-1/4"	11"	14' 11-1/4"	7' 5-1/2"	95	45
5 S	30 E	1' 10"	3' 8-1/4"	11"	10' 6-3/4"	5' 3-1/4"	99	60
5 S	15 E	1' 10"	3' 8-1/4"	11"	5' 5-1/2"	2' 8-3/4"	108	74
5 S	0	1' 10"	3' 8-1/4"	11"	0"	0"	180	85
5 S	15 W	1' 10"	3' 8-1/4"	11"	5' 5-1/2"	2' 8-3/4"	252	74
5 S	30 W	1' 10"	3' 8-1/4"	11"	10' 6-3/4"	5' 3-1/4"	261	60
5 S	45 W	1' 10"	3' 8-1/4"	11"	14' 11-1/4"	7' 5-1/2"	265	45
5 S	60 W	1' 10"	3' 8-1/4"	11"	18' 3-1/2"	9' 1-3/4"	267	30



AJ4CO Observatory Diagram

SIZE	DATE	PART NUMBER	REV
A	01 OCT 2014	N/A	
SCALE	NONE	DRAWN BY	SHEET
		DAVE TYPINSKI	8 OF 12

TFD Array Beam Steering

Time Delay Cable VoP: **66%** Array elements N-S baseline spacing (feet): **32**
 Array elements E-W baseline spacing (feet): **32**

N-S Offset (degrees)	E-W Offset (degrees)	Delay Cable Lengths (feet & inches)					AZ (degrees)	EL (degrees)
		A (S) / B (N)	C (S) / D (N)	E	F (W) / G (E)	H		
10 S	60 E	3' 8"	7' 4"	1' 10"	18' 3-1/2"	9' 1-3/4"	96	30
10 S	45 E	3' 8"	7' 4"	1' 10"	14' 11-1/4"	7' 5-1/2"	100	45
10 S	30 E	3' 8"	7' 4"	1' 10"	10' 6-3/4"	5' 3-1/4"	107	59
10 S	15 E	3' 8"	7' 4"	1' 10"	5' 5-1/2"	2' 8-3/4"	123	72
10 S	0	3' 8"	7' 4"	1' 10"	0"	0"	180	80
10 S	15 W	3' 8"	7' 4"	1' 10"	5' 5-1/2"	2' 8-3/4"	237	72
10 S	30 W	3' 8"	7' 4"	1' 10"	10' 6-3/4"	5' 3-1/4"	253	59
10 S	45 W	3' 8"	7' 4"	1' 10"	14' 11-1/4"	7' 5-1/2"	260	45
10 S	60 W	3' 8"	7' 4"	1' 10"	18' 3-1/2"	9' 1-3/4"	264	30
<hr/>								
15 S	60 E	5' 5-1/2"	10' 11-1/4"	2' 8-3/4"	18' 3-1/2"	9' 1-3/4"	99	30
15 S	45 E	5' 5-1/2"	10' 11-1/4"	2' 8-3/4"	14' 11-1/4"	7' 5-1/2"	105	44
15 S	30 E	5' 5-1/2"	10' 11-1/4"	2' 8-3/4"	10' 6-3/4"	5' 3-1/4"	115	58
15 S	15 E	5' 5-1/2"	10' 11-1/4"	2' 8-3/4"	5' 5-1/2"	2' 8-3/4"	135	69
15 S	0	5' 5-1/2"	10' 11-1/4"	2' 8-3/4"	0"	0"	180	75
15 S	15 W	5' 5-1/2"	10' 11-1/4"	2' 8-3/4"	5' 5-1/2"	2' 8-3/4"	225	69
15 S	30 W	5' 5-1/2"	10' 11-1/4"	2' 8-3/4"	10' 6-3/4"	5' 3-1/4"	245	58
15 S	45 W	5' 5-1/2"	10' 11-1/4"	2' 8-3/4"	14' 11-1/4"	7' 5-1/2"	255	44
15 S	60 W	5' 5-1/2"	10' 11-1/4"	2' 8-3/4"	18' 3-1/2"	9' 1-3/4"	261	30
<hr/>								
20 S	60 E	7' 2-3/4"	14' 5-1/4"	3' 7-1/4"	18' 3-1/2"	9' 1-3/4"	102	29
20 S	45 E	7' 2-3/4"	14' 5-1/4"	3' 7-1/4"	14' 11-1/4"	7' 5-1/2"	110	43
20 S	30 E	7' 2-3/4"	14' 5-1/4"	3' 7-1/4"	10' 6-3/4"	5' 3-1/4"	122	56
20 S	15 E	7' 2-3/4"	14' 5-1/4"	3' 7-1/4"	5' 5-1/2"	2' 8-3/4"	144	66
20 S	0	7' 2-3/4"	14' 5-1/4"	3' 7-1/4"	0"	0"	180	70
20 S	15 W	7' 2-3/4"	14' 5-1/4"	3' 7-1/4"	5' 5-1/2"	2' 8-3/4"	216	66
20 S	30 W	7' 2-3/4"	14' 5-1/4"	3' 7-1/4"	10' 6-3/4"	5' 3-1/4"	238	56
20 S	45 W	7' 2-3/4"	14' 5-1/4"	3' 7-1/4"	14' 11-1/4"	7' 5-1/2"	250	43
20 S	60 W	7' 2-3/4"	14' 5-1/4"	3' 7-1/4"	18' 3-1/2"	9' 1-3/4"	258	29



AJ4CO Observatory Diagram

SIZE A	DATE 01 OCT 2014	PART NUMBER N/A	REV
SCALE NONE	DRAWN BY DAVE TYPINSKI	SHEET 9 OF 12	

TFD Array Beam Steering

Time Delay Cable VoP: **66%** Array elements N-S baseline spacing (feet): **32**
 Array elements E-W baseline spacing (feet): **32**

N-S Offset (degrees)	E-W Offset (degrees)	Delay Cable Lengths (feet & inches)					AZ (degrees)	EL (degrees)
		A (S) / B (N)	C (S) / D (N)	E	F (W) / G (E)	H		
25 S	60 E	8' 11"	17' 10-1/4"	4' 5-1/2"	18' 3-1/2"	9' 1-3/4"	105	29
25 S	45 E	8' 11"	17' 10-1/4"	4' 5-1/2"	14' 11-1/4"	7' 5-1/2"	115	42
25 S	30 E	8' 11"	17' 10-1/4"	4' 5-1/2"	10' 6-3/4"	5' 3-1/4"	129	53
25 S	15 E	8' 11"	17' 10-1/4"	4' 5-1/2"	5' 5-1/2"	2' 8-3/4"	150	62
25 S	0	8' 11"	17' 10-1/4"	4' 5-1/2"	0"	0"	180	65
25 S	15 W	8' 11"	17' 10-1/4"	4' 5-1/2"	5' 5-1/2"	2' 8-3/4"	210	62
25 S	30 W	8' 11"	17' 10-1/4"	4' 5-1/2"	10' 6-3/4"	5' 3-1/4"	231	53
25 S	45 W	8' 11"	17' 10-1/4"	4' 5-1/2"	14' 11-1/4"	7' 5-1/2"	245	42
25 S	60 W	8' 11"	17' 10-1/4"	4' 5-1/2"	18' 3-1/2"	9' 1-3/4"	255	29
<hr/>								
30 S	60 E	10' 6-3/4"	21' 1-1/2"	5' 3-1/4"	18' 3-1/2"	9' 1-3/4"	108	29
30 S	45 E	10' 6-3/4"	21' 1-1/2"	5' 3-1/4"	14' 11-1/4"	7' 5-1/2"	120	41
30 S	30 E	10' 6-3/4"	21' 1-1/2"	5' 3-1/4"	10' 6-3/4"	5' 3-1/4"	135	51
30 S	15 E	10' 6-3/4"	21' 1-1/2"	5' 3-1/4"	5' 5-1/2"	2' 8-3/4"	155	58
30 S	0	10' 6-3/4"	21' 1-1/2"	5' 3-1/4"	0"	0"	180	60
30 S	15 W	10' 6-3/4"	21' 1-1/2"	5' 3-1/4"	5' 5-1/2"	2' 8-3/4"	205	58
30 S	30 W	10' 6-3/4"	21' 1-1/2"	5' 3-1/4"	10' 6-3/4"	5' 3-1/4"	225	51
30 S	45 W	10' 6-3/4"	21' 1-1/2"	5' 3-1/4"	14' 11-1/4"	7' 5-1/2"	240	41
30 S	60 W	10' 6-3/4"	21' 1-1/2"	5' 3-1/4"	18' 3-1/2"	9' 1-3/4"	252	29
<hr/>								
35 S	60 E	12' 1-1/4"	24' 2-3/4"	6' 0-3/4"	18' 3-1/2"	9' 1-3/4"	112	28
35 S	45 E	12' 1-1/4"	24' 2-3/4"	6' 0-3/4"	14' 11-1/4"	7' 5-1/2"	125	39
35 S	30 E	12' 1-1/4"	24' 2-3/4"	6' 0-3/4"	10' 6-3/4"	5' 3-1/4"	140	48
35 S	15 E	12' 1-1/4"	24' 2-3/4"	6' 0-3/4"	5' 5-1/2"	2' 8-3/4"	159	53
35 S	0	12' 1-1/4"	24' 2-3/4"	6' 0-3/4"	0"	0"	180	55
35 S	15 W	12' 1-1/4"	24' 2-3/4"	6' 0-3/4"	5' 5-1/2"	2' 8-3/4"	201	53
35 S	30 W	12' 1-1/4"	24' 2-3/4"	6' 0-3/4"	10' 6-3/4"	5' 3-1/4"	220	48
35 S	45 W	12' 1-1/4"	24' 2-3/4"	6' 0-3/4"	14' 11-1/4"	7' 5-1/2"	235	39
35 S	60 W	12' 1-1/4"	24' 2-3/4"	6' 0-3/4"	18' 3-1/2"	9' 1-3/4"	248	28



AJ4CO Observatory Diagram

SIZE	DATE	PART NUMBER	REV
A	01 OCT 2014	N/A	
SCALE	NONE	DRAWN BY	SHEET
		DAVE TYPINSKI	10 OF 12

TFD Array Beam Steering

Time Delay Cable VoP: 66% **Array elements N-S baseline spacing (feet): 32**
Array elements E-W baseline spacing (feet): 32

N-S Offset (degrees)	E-W Offset (degrees)	Delay Cable Lengths (feet & inches)					AZ (degrees)	EL (degrees)
		A (S) / B (N)	C (S) / D (N)	E	F (W) / G (E)	H		
40 S	60 E	13' 7"	27' 1-3/4"	6' 9-1/2"	18' 3-1/2"	9' 1-3/4"	116	27
40 S	45 E	13' 7"	27' 1-3/4"	6' 9-1/2"	14' 11-1/4"	7' 5-1/2"	130	37
40 S	30 E	13' 7"	27' 1-3/4"	6' 9-1/2"	10' 6-3/4"	5' 3-1/4"	145	44
40 S	15 E	13' 7"	27' 1-3/4"	6' 9-1/2"	5' 5-1/2"	2' 8-3/4"	162	49
40 S	0	13' 7"	27' 1-3/4"	6' 9-1/2"	0"	0"	180	50
40 S	15 W	13' 7"	27' 1-3/4"	6' 9-1/2"	5' 5-1/2"	2' 8-3/4"	198	49
40 S	30 W	13' 7"	27' 1-3/4"	6' 9-1/2"	10' 6-3/4"	5' 3-1/4"	215	44
40 S	45 W	13' 7"	27' 1-3/4"	6' 9-1/2"	14' 11-1/4"	7' 5-1/2"	230	37
40 S	60 W	13' 7"	27' 1-3/4"	6' 9-1/2"	18' 3-1/2"	9' 1-3/4"	244	27
45 S	60 E	14' 11-1/4"	29' 10-1/2"	7' 5-1/2"	18' 3-1/2"	9' 1-3/4"	120	27
45 S	45 E	14' 11-1/4"	29' 10-1/2"	7' 5-1/2"	14' 11-1/4"	7' 5-1/2"	135	35
45 S	30 E	14' 11-1/4"	29' 10-1/2"	7' 5-1/2"	10' 6-3/4"	5' 3-1/4"	150	41
45 S	15 E	14' 11-1/4"	29' 10-1/2"	7' 5-1/2"	5' 5-1/2"	2' 8-3/4"	165	44
45 S	0	14' 11-1/4"	29' 10-1/2"	7' 5-1/2"	0"	0"	180	45
45 S	15 W	14' 11-1/4"	29' 10-1/2"	7' 5-1/2"	5' 5-1/2"	2' 8-3/4"	195	44
45 S	30 W	14' 11-1/4"	29' 10-1/2"	7' 5-1/2"	10' 6-3/4"	5' 3-1/4"	210	41
45 S	45 W	14' 11-1/4"	29' 10-1/2"	7' 5-1/2"	14' 11-1/4"	7' 5-1/2"	225	35
45 S	60 W	14' 11-1/4"	29' 10-1/2"	7' 5-1/2"	18' 3-1/2"	9' 1-3/4"	240	27
50 S	60 E	16' 2-1/4"	32' 4-1/4"	8' 1"	18' 3-1/2"	9' 1-3/4"	125	25
50 S	45 E	16' 2-1/4"	32' 4-1/4"	8' 1"	14' 11-1/4"	7' 5-1/2"	140	33
50 S	30 E	16' 2-1/4"	32' 4-1/4"	8' 1"	10' 6-3/4"	5' 3-1/4"	154	37
50 S	15 E	16' 2-1/4"	32' 4-1/4"	8' 1"	5' 5-1/2"	2' 8-3/4"	167	39
50 S	0	16' 2-1/4"	32' 4-1/4"	8' 1"	0"	0"	180	40
50 S	15 W	16' 2-1/4"	32' 4-1/4"	8' 1"	5' 5-1/2"	2' 8-3/4"	193	39
50 S	30 W	16' 2-1/4"	32' 4-1/4"	8' 1"	10' 6-3/4"	5' 3-1/4"	206	37
50 S	45 W	16' 2-1/4"	32' 4-1/4"	8' 1"	14' 11-1/4"	7' 5-1/2"	220	33
50 S	60 W	16' 2-1/4"	32' 4-1/4"	8' 1"	18' 3-1/2"	9' 1-3/4"	235	25



AJ4CO Observatory Diagram

SIZE A	DATE 01 OCT 2014	PART NUMBER N/A	REV
SCALE NONE	DRAWN BY DAVE TYPINSKI	SHEET 11 OF 12	

TFD Array Beam Steering

Time Delay Cable VoP: **66%** Array elements N-S baseline spacing (feet): **32**
 Array elements E-W baseline spacing (feet): **32**

N-S Offset (degrees)	E-W Offset (degrees)	Delay Cable Lengths (feet & inches)					AZ (degrees)	EL (degrees)
		A (S) / B (N)	C (S) / D (N)	E	F (W) / G (E)	H		
55 S	60 E	17' 3-1/2"	34' 7-1/4"	8' 7-3/4"	18' 3-1/2"	9' 1-3/4"	130	24
55 S	45 E	17' 3-1/2"	34' 7-1/4"	8' 7-3/4"	14' 11-1/4"	7' 5-1/2"	145	30
55 S	30 E	17' 3-1/2"	34' 7-1/4"	8' 7-3/4"	10' 6-3/4"	5' 3-1/4"	158	33
55 S	15 E	17' 3-1/2"	34' 7-1/4"	8' 7-3/4"	5' 5-1/2"	2' 8-3/4"	169	35
55 S	0	17' 3-1/2"	34' 7-1/4"	8' 7-3/4"	0"	0"	180	35
55 S	15 W	17' 3-1/2"	34' 7-1/4"	8' 7-3/4"	5' 5-1/2"	2' 8-3/4"	191	35
55 S	30 W	17' 3-1/2"	34' 7-1/4"	8' 7-3/4"	10' 6-3/4"	5' 3-1/4"	202	33
55 S	45 W	17' 3-1/2"	34' 7-1/4"	8' 7-3/4"	14' 11-1/4"	7' 5-1/2"	215	30
55 S	60 W	17' 3-1/2"	34' 7-1/4"	8' 7-3/4"	18' 3-1/2"	9' 1-3/4"	230	24
<hr/>								
60 S	60 E	18' 3-1/2"	36' 7"	9' 1-3/4"	18' 3-1/2"	9' 1-3/4"	135	22
60 S	45 E	18' 3-1/2"	36' 7"	9' 1-3/4"	14' 11-1/4"	7' 5-1/2"	150	27
60 S	30 E	18' 3-1/2"	36' 7"	9' 1-3/4"	10' 6-3/4"	5' 3-1/4"	162	29
60 S	15 E	18' 3-1/2"	36' 7"	9' 1-3/4"	5' 5-1/2"	2' 8-3/4"	171	30
60 S	0	18' 3-1/2"	36' 7"	9' 1-3/4"	0"	0"	180	30
60 S	15 W	18' 3-1/2"	36' 7"	9' 1-3/4"	5' 5-1/2"	2' 8-3/4"	189	30
60 S	30 W	18' 3-1/2"	36' 7"	9' 1-3/4"	10' 6-3/4"	5' 3-1/4"	198	29
60 S	45 W	18' 3-1/2"	36' 7"	9' 1-3/4"	14' 11-1/4"	7' 5-1/2"	210	27
60 S	60 W	18' 3-1/2"	36' 7"	9' 1-3/4"	18' 3-1/2"	9' 1-3/4"	225	22



AJ4CO Observatory Diagram

SIZE A	DATE 01 OCT 2014	PART NUMBER N/A	REV
SCALE NONE	DRAWN BY DAVE TYPINSKI	SHEET 12 OF 12	

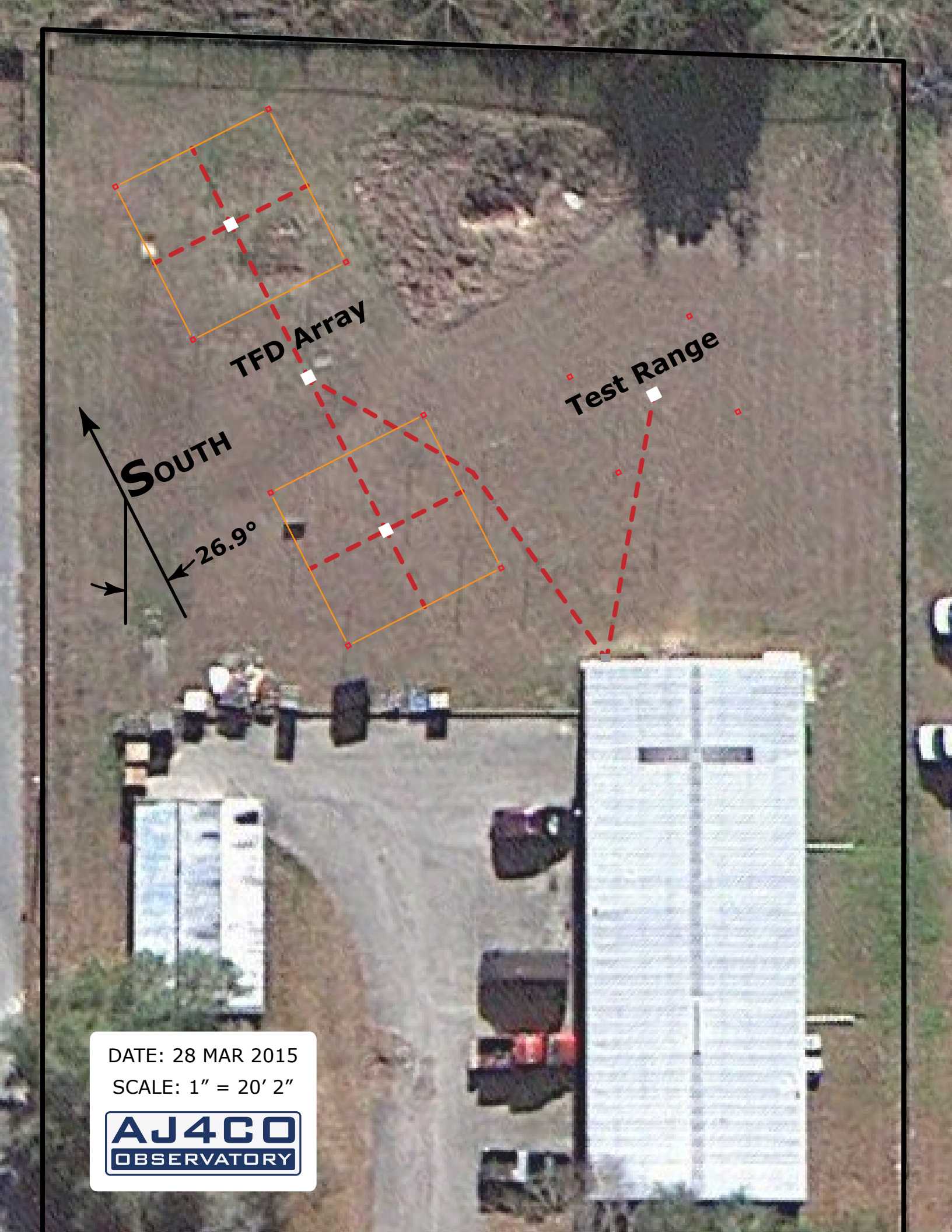

TFD Array

Test Range

SOUTH

26.9°

DATE: 28 MAR 2015

SCALE: 1" = 20' 2"

AJ4CO
OBSERVATORY

UFRO

AJ400
OBSERVATORY

LGM

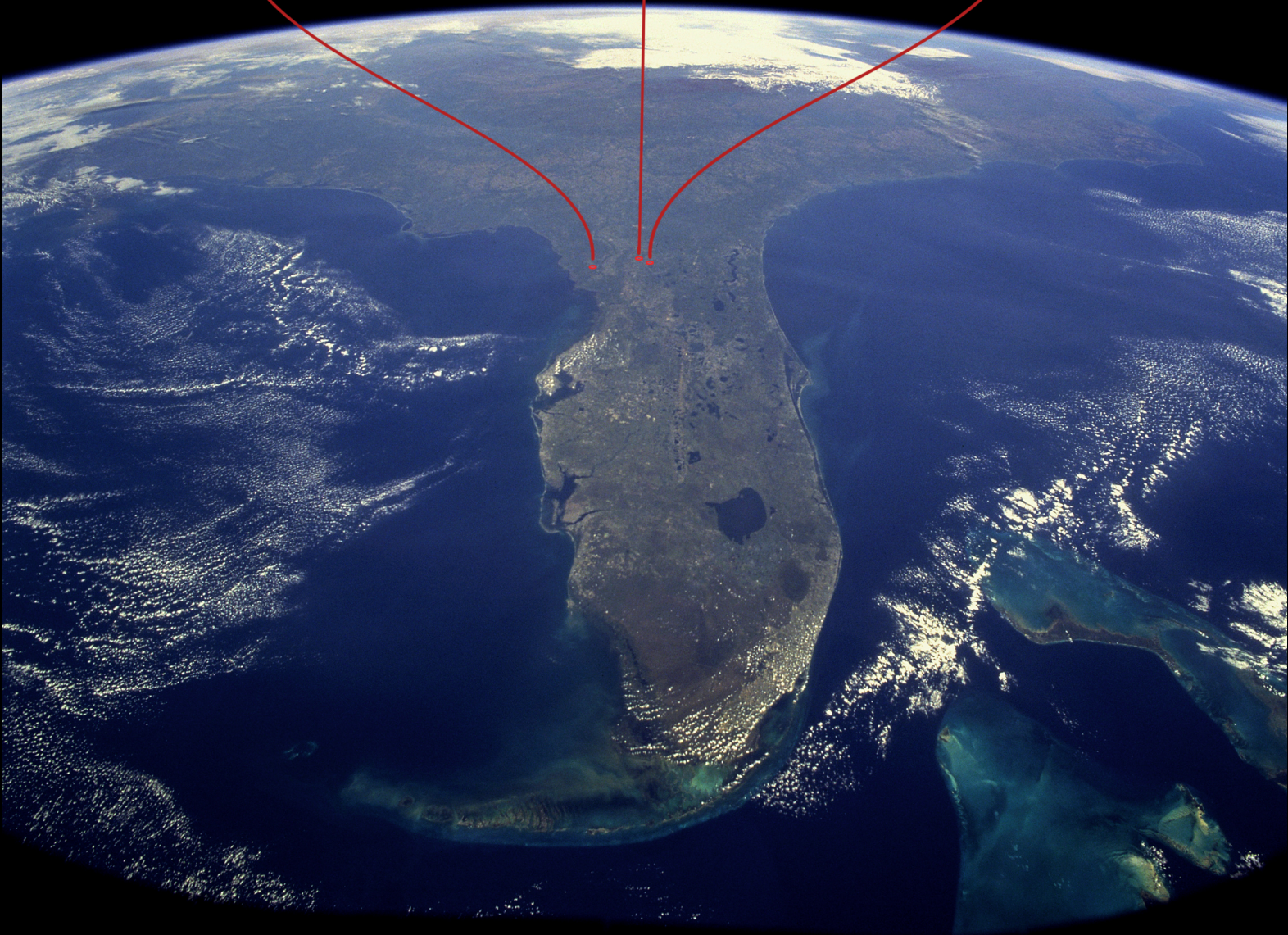

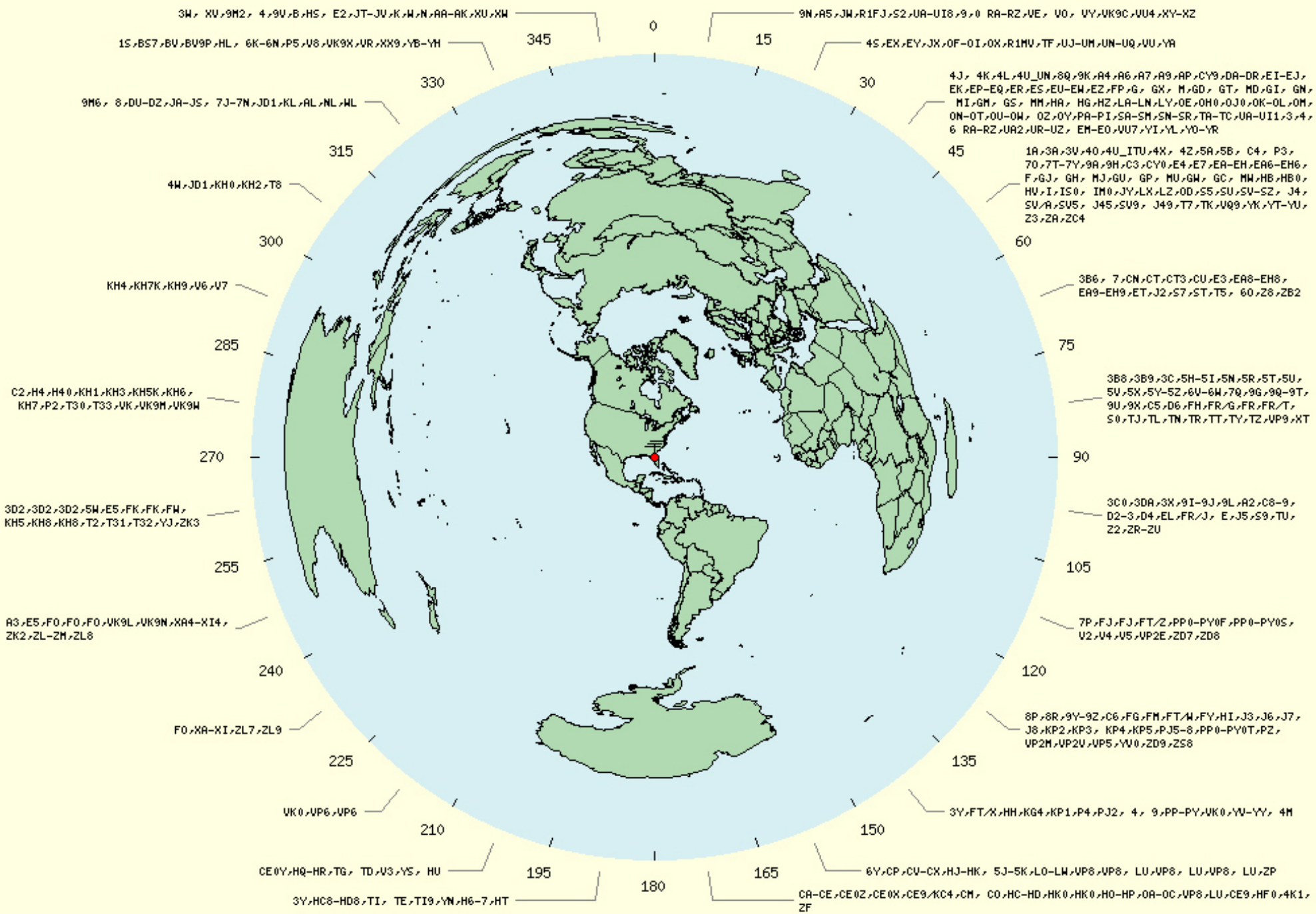



Find the magnetic declination at your location

Find your location or click on the map to display your magnetic declination

[Browse countries](#) [What is Magnetic Declination?](#)

Sites of Interest

[Real Time Cinema](#)

[Satellite tracking](#)

[Radio Astronomy](#)

Find your location

high springs

USA

FLORIDA

::SEARCH MAP::

[Browse countries](#)

1 HIGH SPRINGS FL

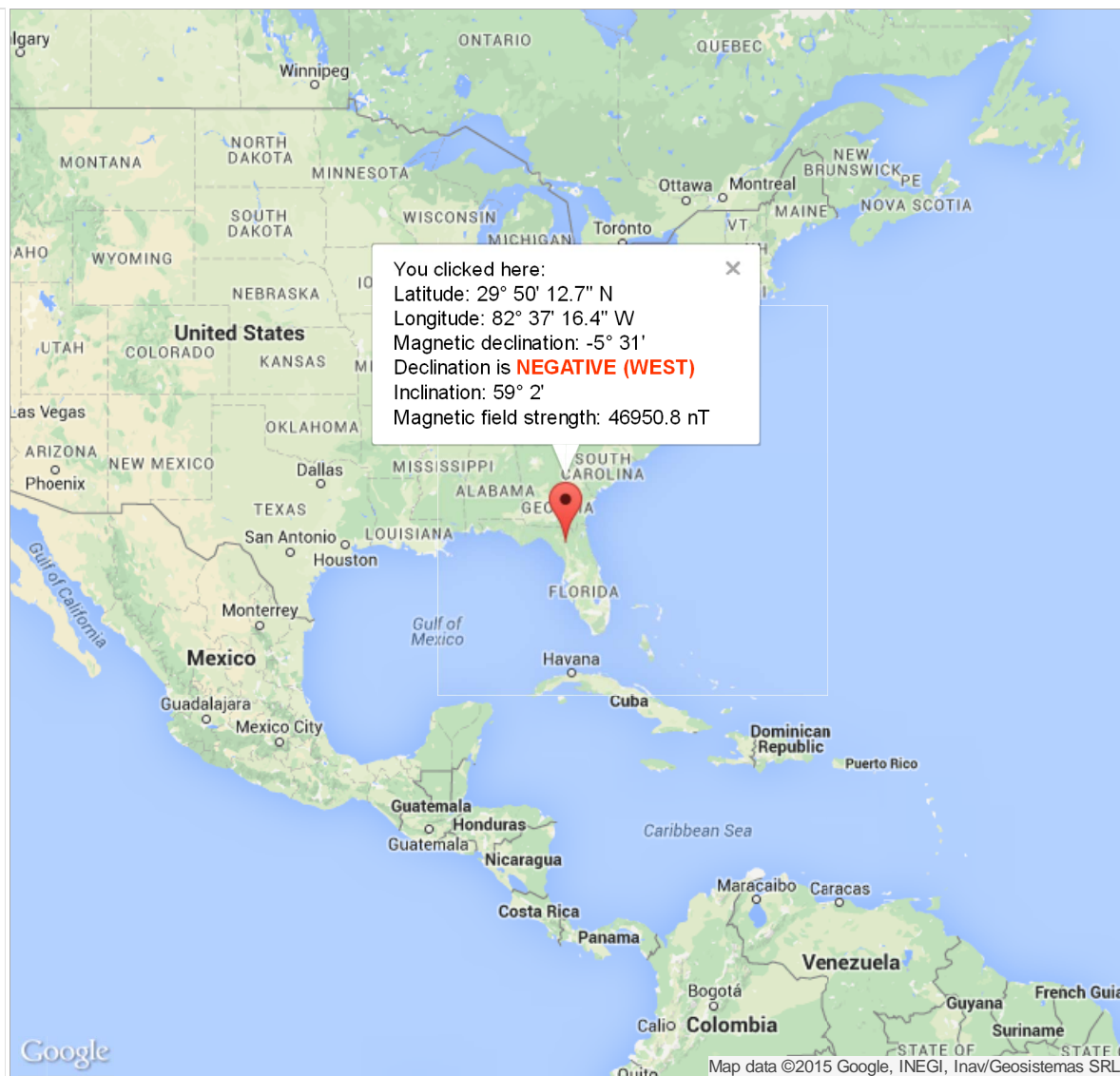

Copyright ©2015 Magnetic-Declination.com
 Questions? webmaster@magnetic-declination.com



**Check your
declination**

Find the magnetic declination at your location

What is Magnetic Declination?

Did you know that magnetic compass does not always point to North? Actually, there are only a few locations on Earth where it points exactly to the True (geographic) North. The direction in which the compass needle points is known as Magnetic North, and the angle between Magnetic North and the True North direction is called **magnetic declination**.

Magnetic declination varies both from place to place, and with the passage of time. As a traveller cruises the east coast of the United States, for example, the declination varies from 20 degrees west (in Maine) to zero (in Florida), to 10 degrees east (in Texas), meaning a compass adjusted at the beginning of the journey would have a true north error of over 30 degrees if not adjusted for the changing declination. The magnetic declination in a given area will change slowly over time, possibly as much as 2-25 degrees every hundred years or so, depending upon how far from the magnetic poles it is. Complex fluid motion in the outer core of the Earth (the molten metallic region that lies from 2800 to 5000 km below the Earth's surface) causes the magnetic field to change slowly with time. This change is known as secular variation. Because of secular variation, declination values shown on old topographic, marine and aeronautical charts need to be updated if they are to be used without large errors. Unfortunately, the annual change corrections given on most of these maps cannot be applied reliably if the maps are more than a few years old since the secular variation also changes with time in an unpredictable manner.

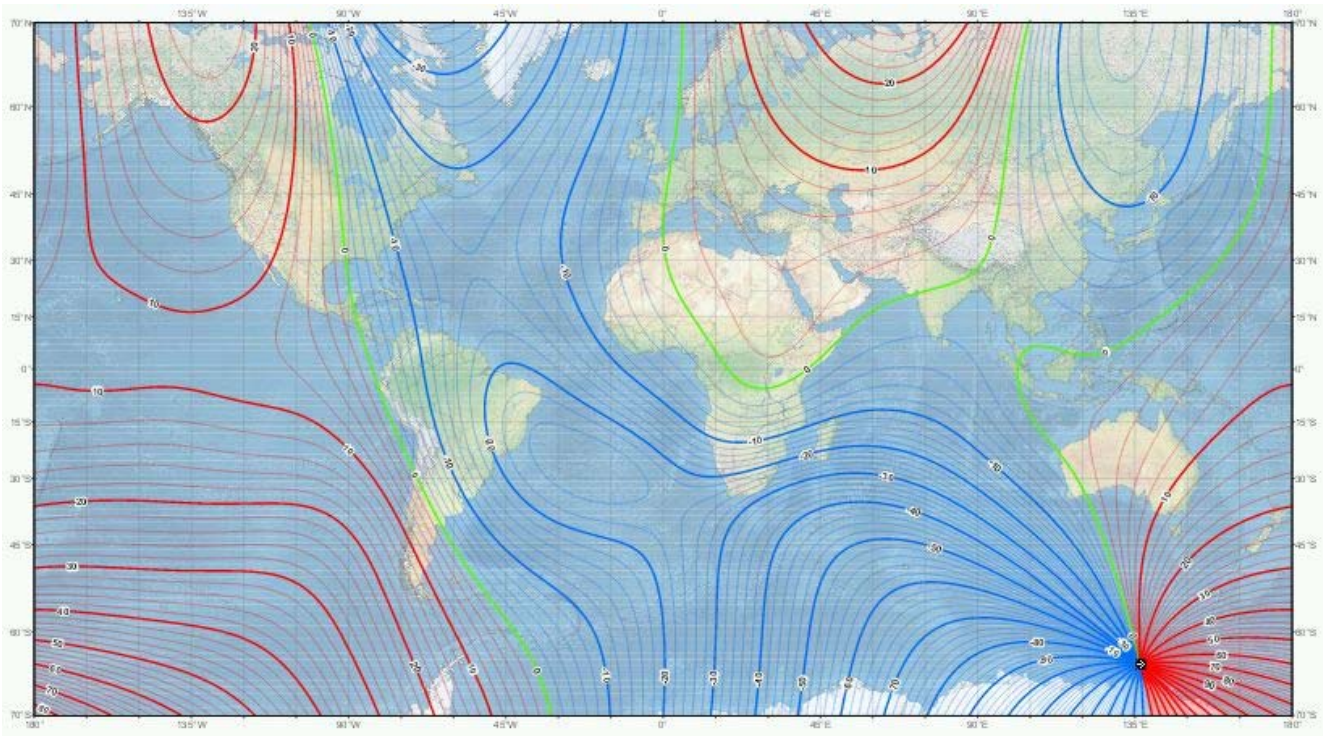

If the compass at your place is pointing **clockwise** with respect to the True North, declination is **positive** or **EAST**

If the compass at your place is pointing **counter-clockwise** with respect to the True North, declination is **negative** or **WEST**

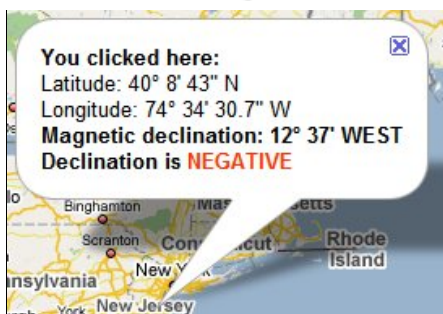
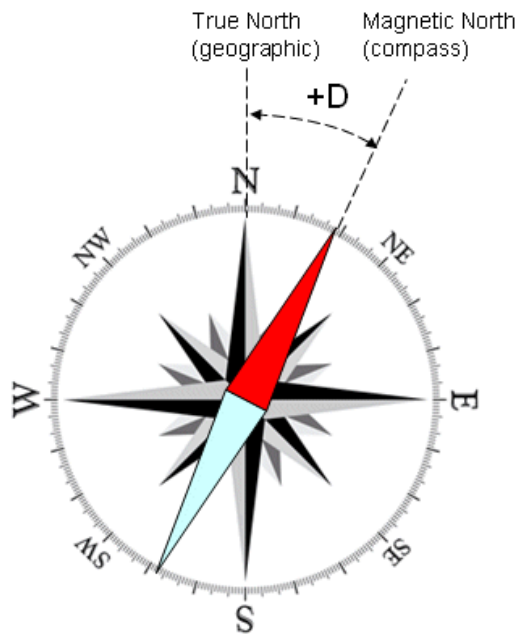
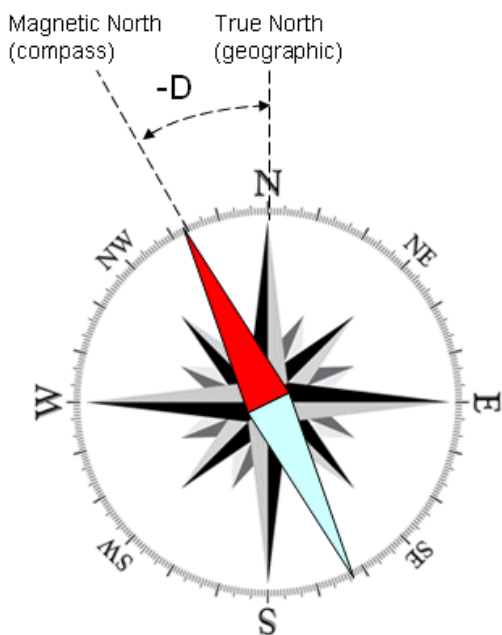

Negative declination (WEST)

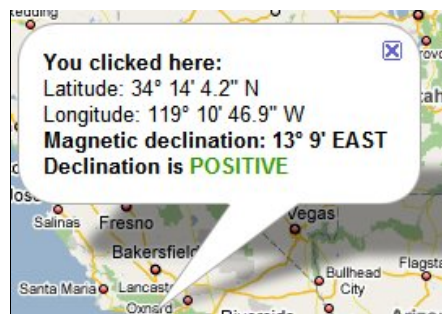

Positive declination (EAST)

How can we calculate declination at any given place?

One way would be to use declination maps. Unfortunately because of secular variation, declination values are constantly changing. When printed maps were the only way of getting this information, the declination values were somewhat out of date by the time the maps got to the general public.

Another way would be to perform a prediction. This should be based on a world-wide empirical model of the deep flows. This [web page](#) operated by the National Geophysical Data Center (NDGC) offers a pretty good value for declination. The model reflects a highly predictable rate of change, and will usually be more accurate than a map, and almost never less accurate.

The best way however is to use [the current web site](#), which offers in a graphical format using Google Maps API the computed declination for any place on Earth. The algorithm implements the [World Magnetic Model WMM2015](#).



Copyright ©2015 Magnetic-Declination.com
 Questions? webmaster@magnetic-declination.com

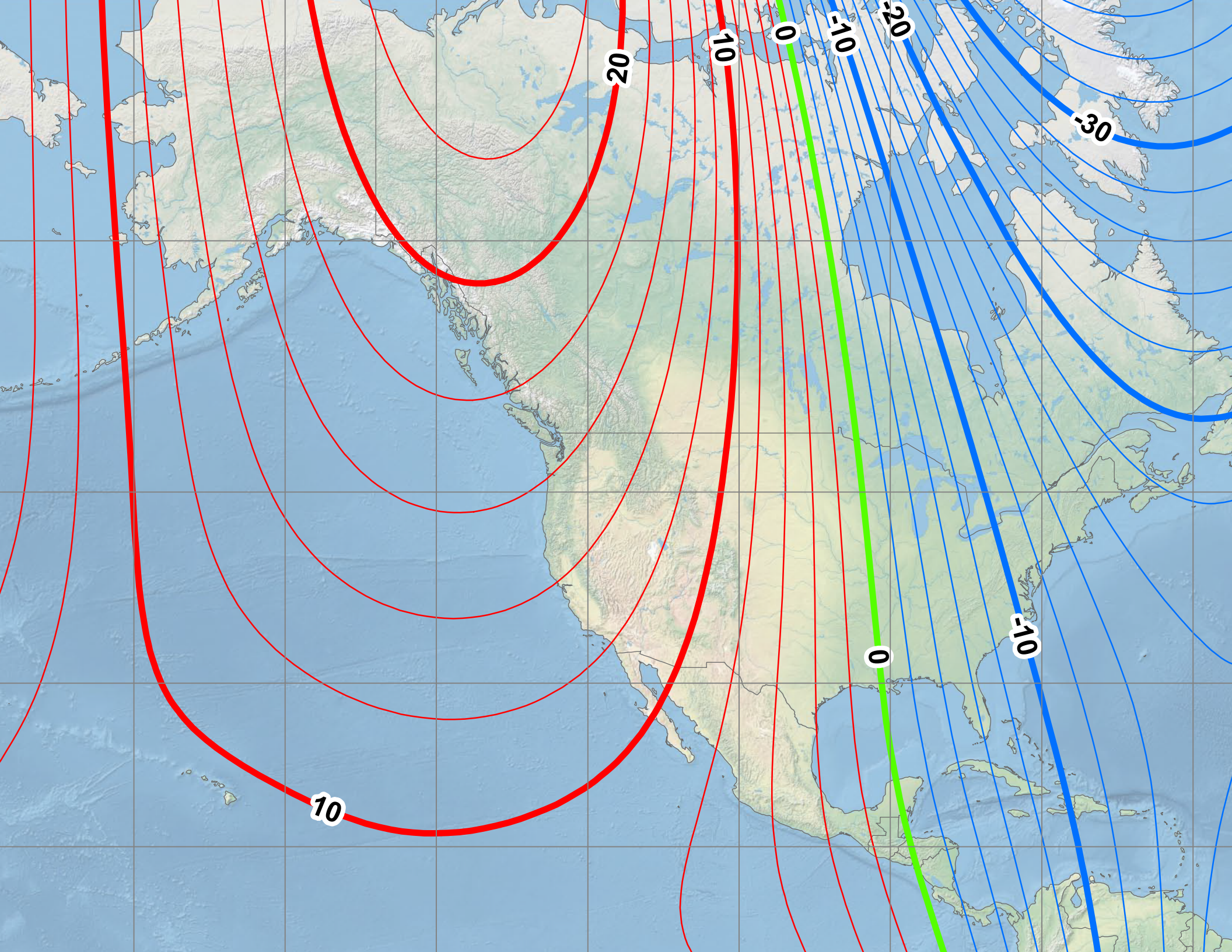

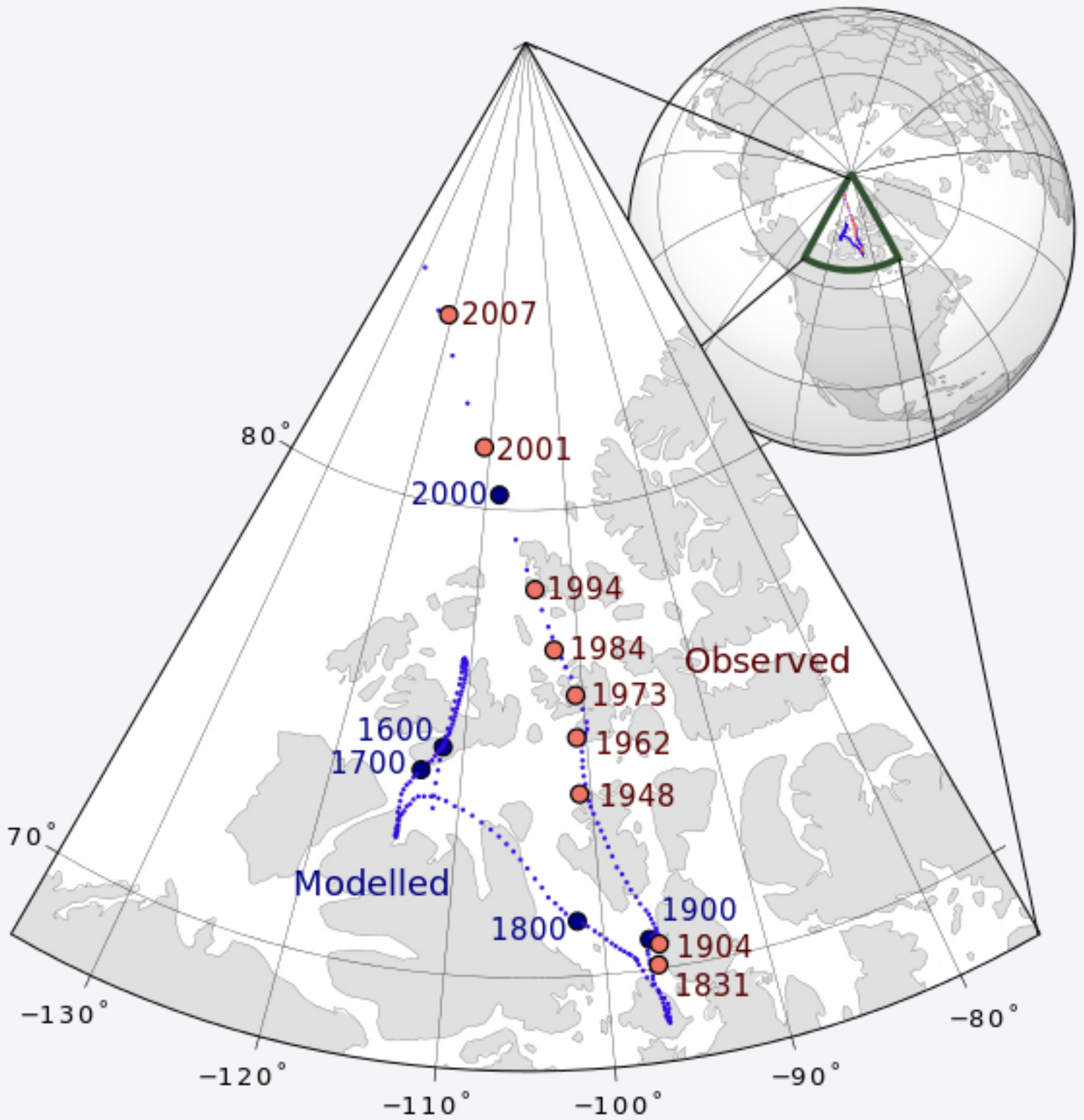

https://en.wikipedia.org/wiki/North_Magnetic_Pole#/media/File:Magnetic_North_Pole_Positions.svg

Dipole Array Estimation of Directivity, Aperture, and HPBW
Assuming beam steered to zenith, no sidelobes, and circular pattern
 Typinski, 2015

Elements (n)	Linear Polarized Arrays In Free Space		Linear Polarized Arrays Above Perfect Ground Plane				Effective Aperture at f = 20.0 MHz (m ²)	zenith beam no sidelobes circular pattern HPBW θ (degs)	Circular Polarized Arrays of Orthogonal Linear Elements Above Perfect Ground Plane Receiving 100% CP Emissions		Effective Aperture at 20.0 MHz (m ²)
	D (dBi)	D (dBd)	D (dBi)	D (dBd)	D (dBi)	D (dBic)					
1	2.2	0	5.2	3	59	134	—	—	—		
2	5.2	3	8.2	6	117	92	11.2	8.2	233		
4	8.2	6	11.2	9	233	64	14.2	11.2	465		
8	11.2	9	14.2	12	465	45	17.2	14.2	928		
16	14.2	12	17.2	15	928	32	20.2	17.2	1,851		
32	17.2	15	20.2	18	1,851	23	23.2	20.2	3,693		
64	20.2	18	23.2	21	3,693	16	26.2	23.2	7,368		
128	23.2	21	26.2	24	7,368	11	29.2	26.2	14,702		
256	26.2	24	29.2	27	14,702	8	32.2	29.2	29,334		
512	29.2	27	32.2	30	29,334	6	35.2	32.2	58,529		
1,024	32.2	30	35.2	33	58,529	4	38.2	35.2	116,781		
2,048	35.2	33	38.2	36	116,781	3	41.2	38.2	233,008		
640	30.1	28	33.1	31	36,640	5	36.1	33.1	73,105		

= dBd + 2.15 = 3 log₂ n

= free space + 3dB

$$= \frac{D_{dBi} \lambda^2}{4\pi}$$

$$dBi = 10 \log \left(\frac{4\pi}{\Omega} \right)$$

$$\Omega = 2\pi \left(1 - \cos \frac{\theta_{HPBW}}{2} \right)$$

$$\theta_{HPBW} = 2 \cos^{-1} \left[1 - 2 \left(10^{-\frac{dBi}{10}} \right) \right]$$

= D_{free space} + 6dB
 3 dB for ground plane
 3 dB for CP emission

= dBi - 3dB

$$= \frac{D_{dBi} \lambda^2}{4\pi}$$