

OBSERVATORY OUTLINE
28 MAR 2015

Location: 29° 50' 13" N 29.8369° N EL89qu
82° 37' 17" W 82.6214° W
53 ft (16 m) MSL

TFD Array: Two square arrays on a NS line, eight 30-foot TFD elements (see attached diagrams), beam steering in 5° increments NS and 15° increments EW.

16 MHz HPBW at zenith: 18° NS x 40° EW

20 MHz HPBW at zenith: 15° NS x 35° EW, $D \approx 14\text{dBic}$

24 MHz HPBW at zenith: 12° NS x 30° EW

32 MHz HPBW at zenith: 8° NS x 20° EW

Receivers: 1 x Dual Polarization Spectrograph (DPS)
24 x 7 x 365 unattended operation
16–32 MHz, correlated RCP and LCP
300 channels per polarization (600 total)
Swept frequency, selectable 7.5, 15, 30, 60 kHz pre-detection BW
~ 6.7 sweeps/sec, integration time = 500 μs per sample

1 x Tunable Wideband Receiver (TWB) Mark III
Attended operation only
Tunable from 16 to 32 MHz, RCP or LCP
2 MHz IF BW direct to high speed digitizer
FFT post-processing, RBW = 4.88 kHz, $\Delta t = 205 \mu\text{s}$

1 x FS-200B radio spectrograph
24 x 7 x 365 unattended operation
16–26 MHz, RCP or LCP, 200 channels
Swept frequency, 30 kHz pre-detection BW
~ 10 sweeps/sec, integration time = 500 μs per sample

2 x Radio Jove receivers
24 x 7 x 365 unattended operation
~ 20.1 MHz, uncorrelated RCP and LCP
7 kHz RF BW folded via direct conversion into
a baseband 3.5 kHz pre-detection BW
integration time = 100 ms per sample

North →

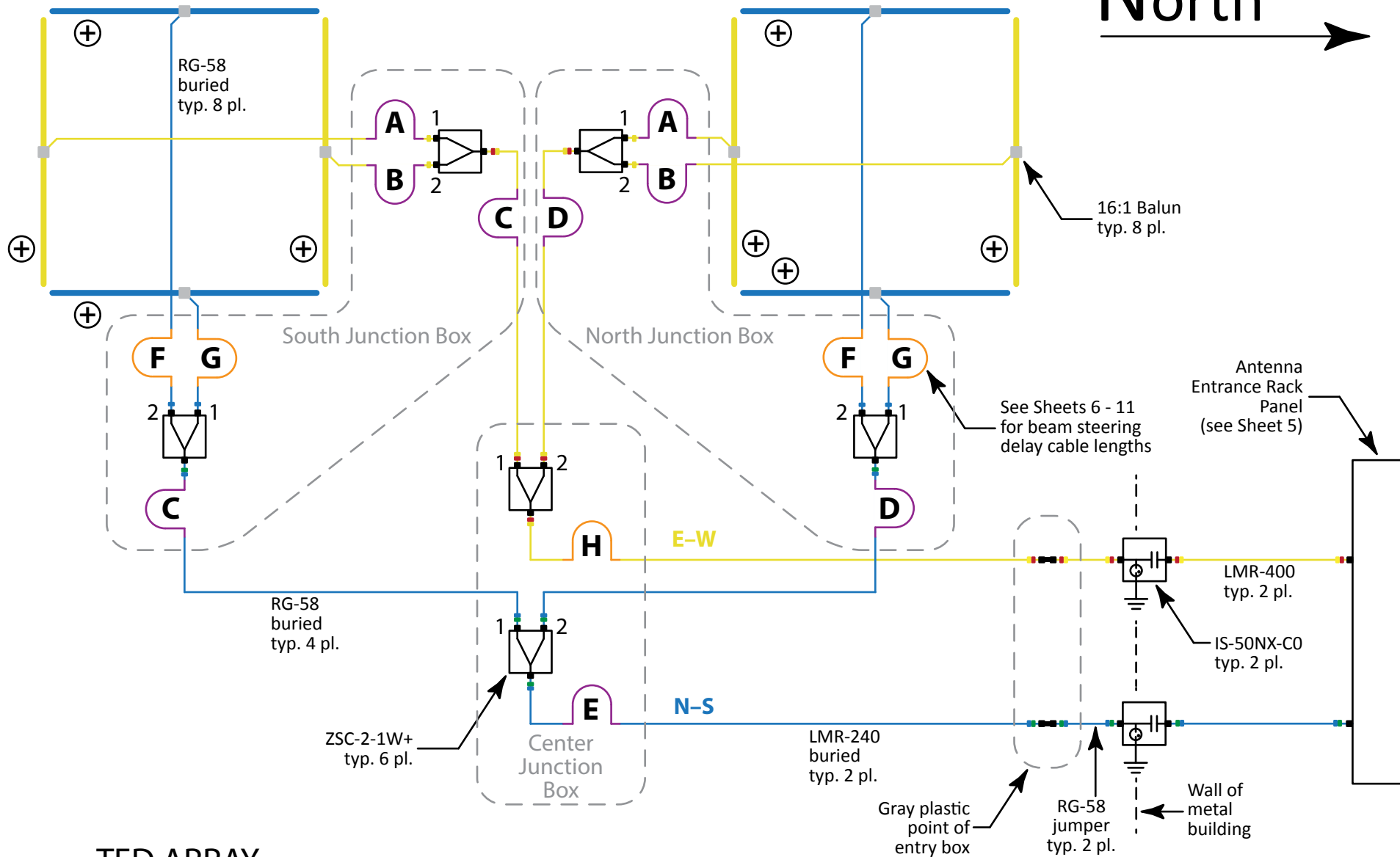

TFD ARRAY CONFIGURATION C CP MODE

See Sheet 5 for XY to CP 90° Hybrid

30' folded dipoles, top wire 9'2" height,
8" wire spacing, 32' element spacing,
800 Ω termination resistors, 16:1 baluns.

See Sheet 4 for feed system measured losses.



AJ4CO Observatory Diagram

SIZE A	DATE 28 MAR 2015	PART NUMBER N/A	REV
SCALE NONE	DRAWN BY DAVE TYPINSKI	SHEET 1 OF 11	

North →

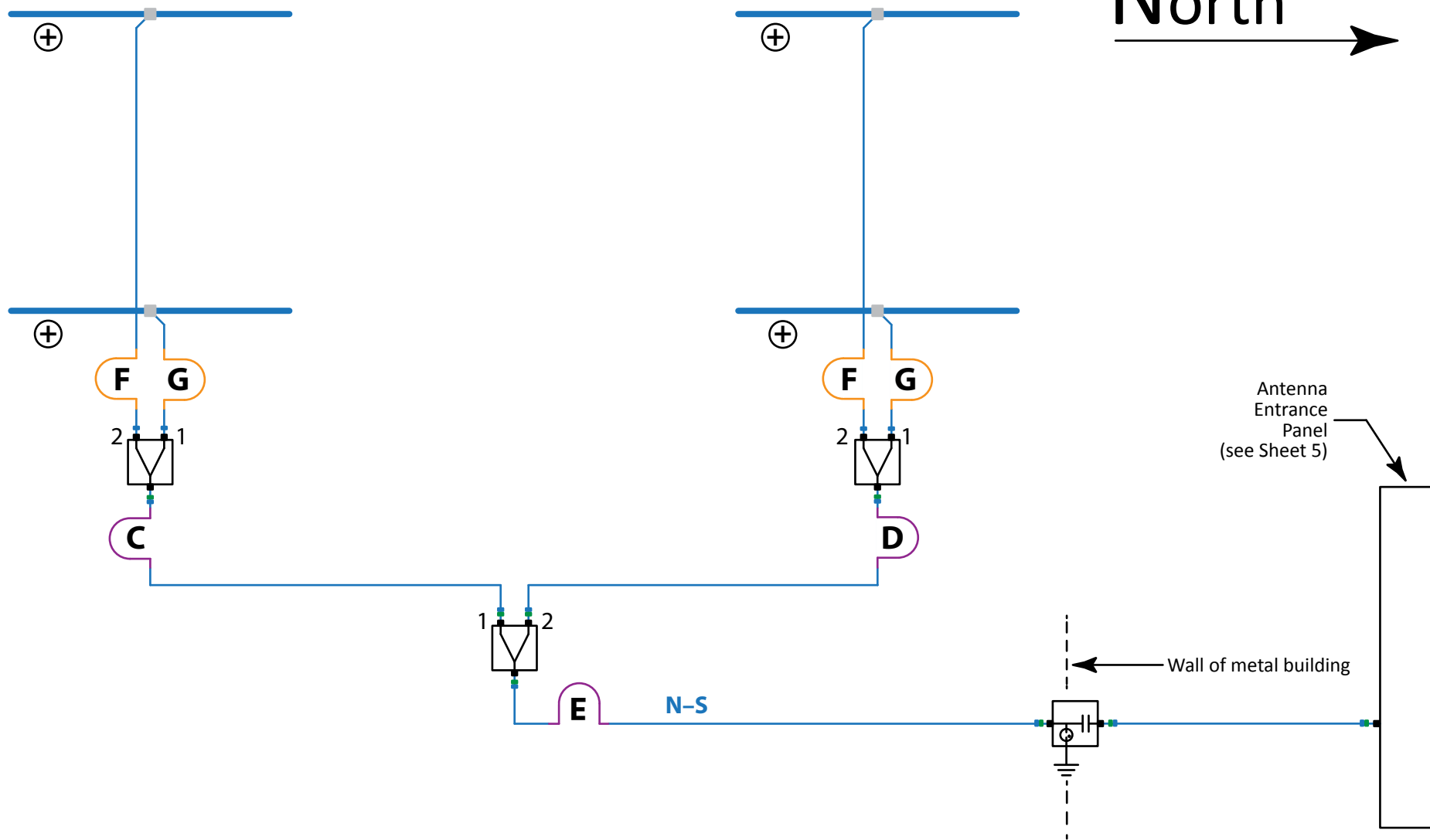

Antenna Entrance Panel (see Sheet 5)

Wall of metal building

North-South Elements Only

		AJ4CO Observatory Diagram		
		SIZE A	DATE 28 MAR 2015	PART NUMBER N/A
SCALE NONE		DRAWN BY DAVE TYPINSKI		SHEET 2 OF 11

North 

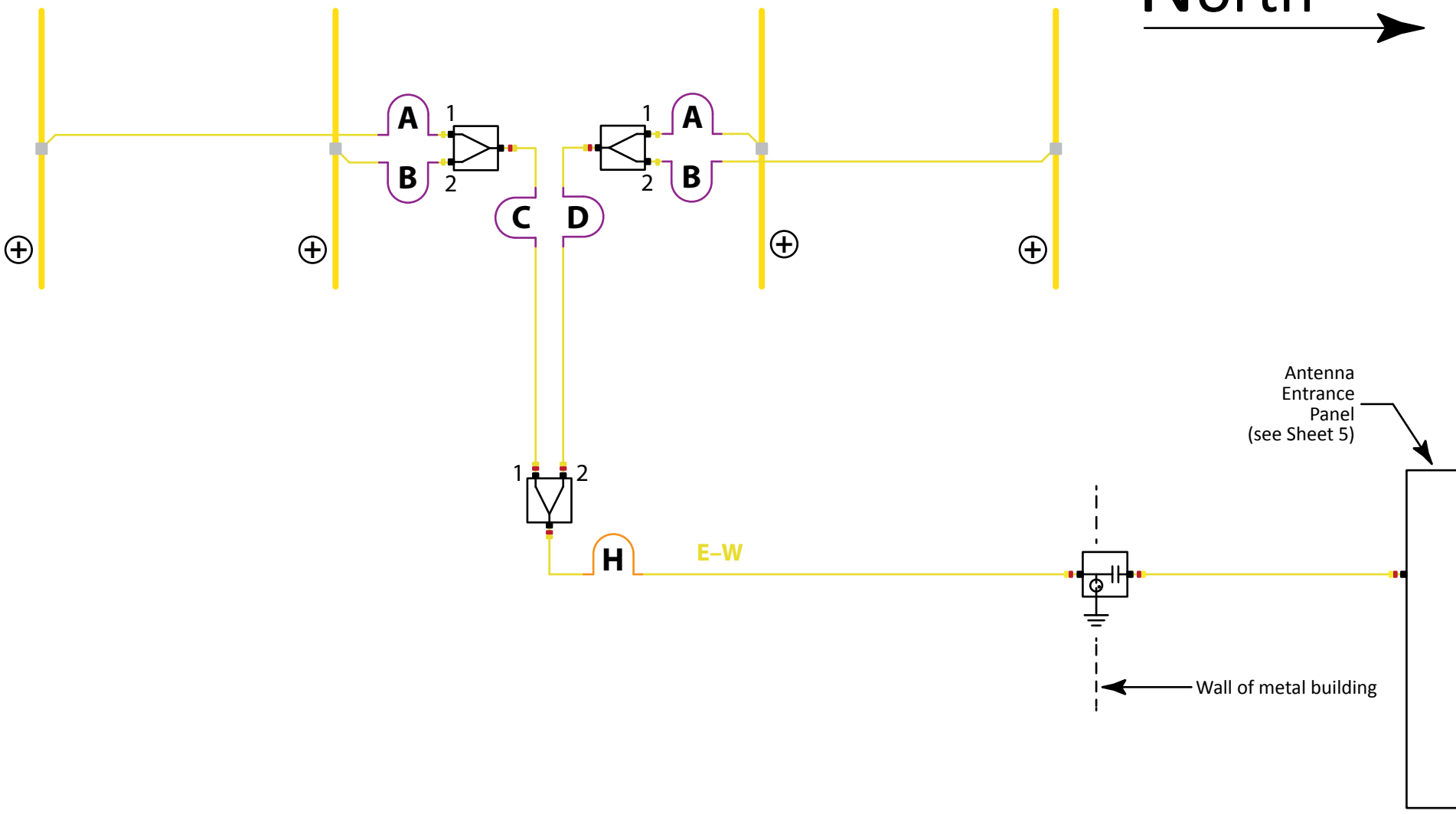

East-West Elements Only

	AJ4CO Observatory Diagram			
	SIZE A	DATE 28 MAR 2015	PART NUMBER N/A	REV
	SCALE NONE	DRAWN BY DAVE TYPINSKI	SHEET 3 OF 11	

TFD Array Feed System Losses

Feed line loss sweeps performed 28 Mar 2015

Device sweeps performed 11 Aug 2013

	Rack panel to gray point of entry box LMR-400	Gray box to center J-box LMR-240	Center J-box to outer J-box RG-58	Outer J-box to element balun RG-58	Synergy DQK-701B 90° Hybrid (one)	Mini-Circuits ZSC-2-1W+ Combiners (two)	AJ4CO BALUN16-1A 16:1 Balun (one)	Loss Between Element Feed Points and Hybrid Outputs (dB)
	One Way	One Way	One Way	One Way	Loss	Loss	Loss	
Freq (MHz)	Loss (dB)	Loss (dB)	Loss (dB)	Loss (dB)	Loss (dB)	Loss (dB)	Loss (dB)	Loss (dB)
16	-0.99	-0.94	-0.75	-0.33	-0.21	-0.40	-0.52	-4.1
18	-1.04	-0.99	-0.79	-0.35	-0.26	-0.41	-0.54	-4.4
20	-1.09	-1.03	-0.84	-0.37	-0.29	-0.42	-0.55	-4.6
22	-1.15	-1.07	-0.89	-0.39	-0.32	-0.43	-0.57	-4.8
24	-1.20	-1.11	-0.93	-0.40	-0.34	-0.44	-0.58	-5.0
26	-1.24	-1.16	-0.97	-0.42	-0.34	-0.45	-0.59	-5.2
28	-1.28	-1.20	-1.00	-0.45	-0.32	-0.47	-0.60	-5.3
30	-1.32	-1.23	-1.04	-0.46	-0.30	-0.49	-0.61	-5.5
32	-1.36	-1.27	-1.09	-0.46	-0.27	-0.50	-0.62	-5.6



AJ4CO Observatory Diagram

SIZE	DATE	PART NUMBER	REV
A	28 MAR 2015	N/A	
SCALE	NONE	DRAWN BY	SHEET
		DAVE TYPINSKI	4 OF 11

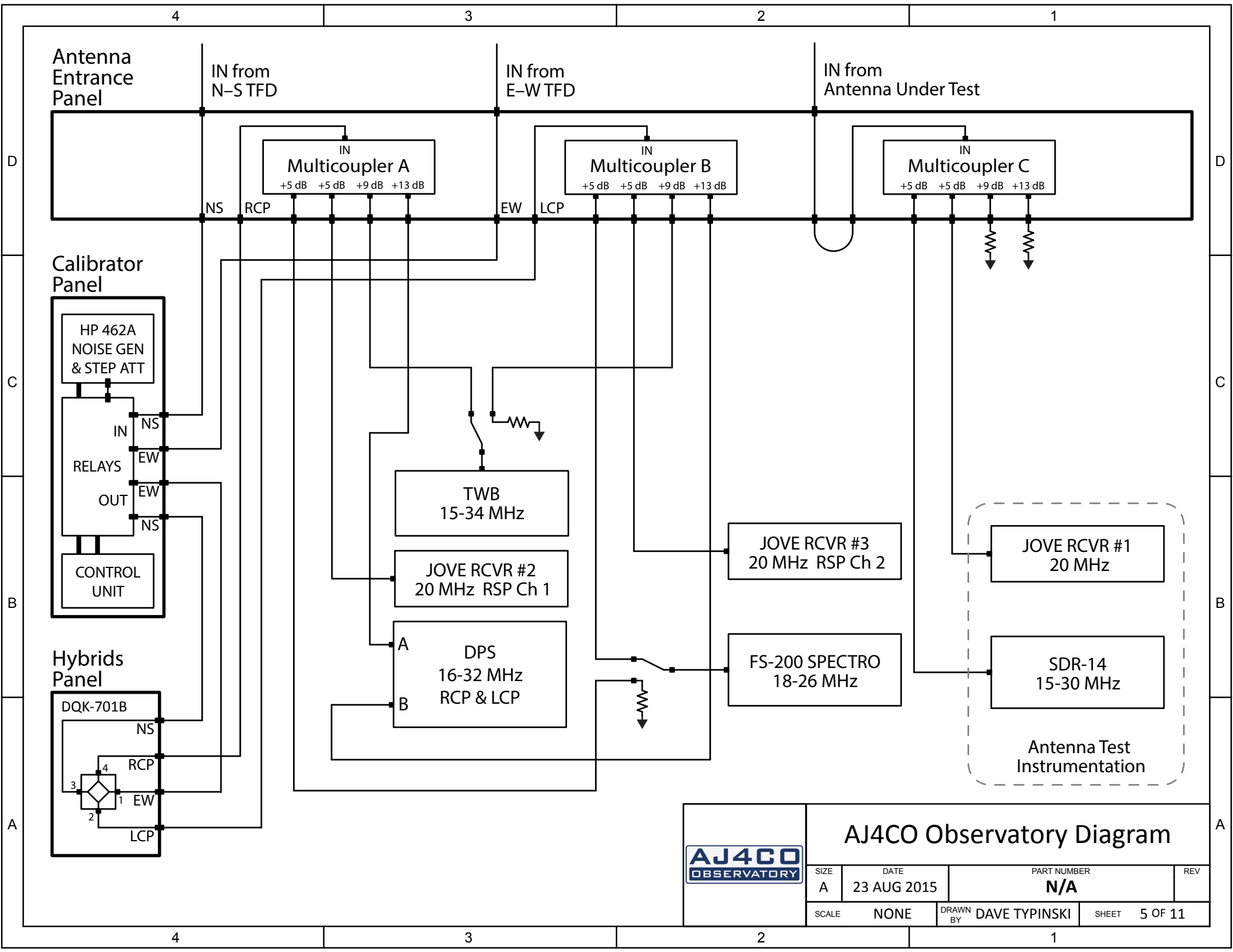

Antenna
Entrance
Panel

IN from
N-STFD

IN from
E-W TFD

IN from
Antenna Under Test

Multicoupler A

+5 dB +5 dB +9 dB +13 dB

Multicoupler B

+5 dB +5 dB +9 dB +13 dB

Multicoupler C

+5 dB +5 dB +9 dB +13 dB

Calibrator
Panel

HP 462A
NOISE GEN
& STEP ATT

RELAYS
IN NS
EW
OUT EW
NS

CONTROL
UNIT

TWB
15-34 MHz

JOVE RCVR #2
20 MHz RSP Ch 1

DPS
16-32 MHz
RCP & LCP

JOVE RCVR #3
20 MHz RSP Ch 2

FS-200 SPECTRO
18-26 MHz

JOVE RCVR #1
20 MHz

SDR-14
15-30 MHz

Antenna Test
Instrumentation

Hybrids
Panel

DQK-701B

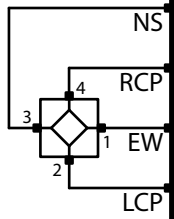

AJ4CO Observatory Diagram

SIZE A	DATE 23 AUG 2015	PART NUMBER N/A	REV
SCALE NONE	DRAWN BY DAVE TYPINSKI	SHEET 5 OF 11	

TFD Array Beam Steering

Time Delay Cable VoP: **66%** ray elements N-S baseline spacing (feet): **32**
 Array elements E-W baseline spacing (feet): **32**

N-S Offset (degrees)	E-W Offset (degrees)	Delay Cable Lengths (feet & inches)					AZ (degrees)	EL (degrees)
		A (S) / B (N)	C (S) / D (N)	E	F (W) / G (E)	H		
20 N	60 E	7' 2-3/4"	14' 5-1/4"	3' 7-1/4"	18' 3-1/2"	9' 1-3/4"	78	29
20 N	45 E	7' 2-3/4"	14' 5-1/4"	3' 7-1/4"	14' 11-1/4"	7' 5-1/2"	70	43
20 N	30 E	7' 2-3/4"	14' 5-1/4"	3' 7-1/4"	10' 6-3/4"	5' 3-1/4"	58	56
20 N	15 E	7' 2-3/4"	14' 5-1/4"	3' 7-1/4"	5' 5-1/2"	2' 8-3/4"	36	66
20 N	0	7' 2-3/4"	14' 5-1/4"	3' 7-1/4"	0"	0"	0	70
20 N	15 W	7' 2-3/4"	14' 5-1/4"	3' 7-1/4"	5' 5-1/2"	2' 8-3/4"	324	66
20 N	30 W	7' 2-3/4"	14' 5-1/4"	3' 7-1/4"	10' 6-3/4"	5' 3-1/4"	302	56
20 N	45 W	7' 2-3/4"	14' 5-1/4"	3' 7-1/4"	14' 11-1/4"	7' 5-1/2"	290	43
20 N	60 W	7' 2-3/4"	14' 5-1/4"	3' 7-1/4"	18' 3-1/2"	9' 1-3/4"	282	29
<hr/>								
15 N	60 E	5' 5-1/2"	10' 11-1/4"	2' 8-3/4"	18' 3-1/2"	9' 1-3/4"	81	30
15 N	45 E	5' 5-1/2"	10' 11-1/4"	2' 8-3/4"	14' 11-1/4"	7' 5-1/2"	75	44
15 N	30 E	5' 5-1/2"	10' 11-1/4"	2' 8-3/4"	10' 6-3/4"	5' 3-1/4"	65	58
15 N	15 E	5' 5-1/2"	10' 11-1/4"	2' 8-3/4"	5' 5-1/2"	2' 8-3/4"	45	69
15 N	0	5' 5-1/2"	10' 11-1/4"	2' 8-3/4"	0"	0"	360	75
15 N	15 W	5' 5-1/2"	10' 11-1/4"	2' 8-3/4"	5' 5-1/2"	2' 8-3/4"	315	69
15 N	30 W	5' 5-1/2"	10' 11-1/4"	2' 8-3/4"	10' 6-3/4"	5' 3-1/4"	295	58
15 N	45 W	5' 5-1/2"	10' 11-1/4"	2' 8-3/4"	14' 11-1/4"	7' 5-1/2"	285	44
15 N	60 W	5' 5-1/2"	10' 11-1/4"	2' 8-3/4"	18' 3-1/2"	9' 1-3/4"	279	30
<hr/>								
10 N	60 E	3' 8"	7' 4"	1' 10"	18' 3-1/2"	9' 1-3/4"	84	30
10 N	45 E	3' 8"	7' 4"	1' 10"	14' 11-1/4"	7' 5-1/2"	80	45
10 N	30 E	3' 8"	7' 4"	1' 10"	10' 6-3/4"	5' 3-1/4"	73	59
10 N	15 E	3' 8"	7' 4"	1' 10"	5' 5-1/2"	2' 8-3/4"	57	72
10 N	0	3' 8"	7' 4"	1' 10"	0"	0"	360	80
10 N	15 W	3' 8"	7' 4"	1' 10"	5' 5-1/2"	2' 8-3/4"	303	72
10 N	30 W	3' 8"	7' 4"	1' 10"	10' 6-3/4"	5' 3-1/4"	287	59
10 N	45 W	3' 8"	7' 4"	1' 10"	14' 11-1/4"	7' 5-1/2"	280	45
10 N	60 W	3' 8"	7' 4"	1' 10"	18' 3-1/2"	9' 1-3/4"	276	30



AJ4CO Observatory Diagram

SIZE A	DATE 01 OCT 2014	PART NUMBER N/A	REV
SCALE NONE	DRAWN BY DAVE TYPINSKI	SHEET 6 OF 11	

TFD Array Beam Steering

Time Delay Cable VoP: **66%** Array elements N-S baseline spacing (feet): **32**
 Array elements E-W baseline spacing (feet): **32**

N-S Offset (degrees)	E-W Offset (degrees)	Delay Cable Lengths (feet & inches)					AZ (degrees)	EL (degrees)
		A (S) / B (N)	C (S) / D (N)	E	F (W) / G (E)	H		
5 N	60 E	1' 10"	3' 8-1/4"	11"	18' 3-1/2"	9' 1-3/4"	87	30
5 N	45 E	1' 10"	3' 8-1/4"	11"	14' 11-1/4"	7' 5-1/2"	85	45
5 N	30 E	1' 10"	3' 8-1/4"	11"	10' 6-3/4"	5' 3-1/4"	81	60
5 N	15 E	1' 10"	3' 8-1/4"	11"	5' 5-1/2"	2' 8-3/4"	72	74
5 N	0	1' 10"	3' 8-1/4"	11"	0"	0"	360	85
5 N	15 W	1' 10"	3' 8-1/4"	11"	5' 5-1/2"	2' 8-3/4"	288	74
5 N	30 W	1' 10"	3' 8-1/4"	11"	10' 6-3/4"	5' 3-1/4"	279	60
5 N	45 W	1' 10"	3' 8-1/4"	11"	14' 11-1/4"	7' 5-1/2"	275	45
5 N	60 W	1' 10"	3' 8-1/4"	11"	18' 3-1/2"	9' 1-3/4"	273	30
<hr/>								
0	60 E	0"	0"	0"	18' 3-1/2"	9' 1-3/4"	90	30
0	45 E	0"	0"	0"	14' 11-1/4"	7' 5-1/2"	90	45
0	30 E	0"	0"	0"	10' 6-3/4"	5' 3-1/4"	90	60
0	15 E	0"	0"	0"	5' 5-1/2"	2' 8-3/4"	90	75
0	0	0"	0"	0"	0"	0"	180	90
0	15 W	0"	0"	0"	5' 5-1/2"	2' 8-3/4"	270	75
0	30 W	0"	0"	0"	10' 6-3/4"	5' 3-1/4"	270	60
0	45 W	0"	0"	0"	14' 11-1/4"	7' 5-1/2"	270	45
0	60 W	0"	0"	0"	18' 3-1/2"	9' 1-3/4"	270	30
<hr/>								
5 S	60 E	1' 10"	3' 8-1/4"	11"	18' 3-1/2"	9' 1-3/4"	93	30
5 S	45 E	1' 10"	3' 8-1/4"	11"	14' 11-1/4"	7' 5-1/2"	95	45
5 S	30 E	1' 10"	3' 8-1/4"	11"	10' 6-3/4"	5' 3-1/4"	99	60
5 S	15 E	1' 10"	3' 8-1/4"	11"	5' 5-1/2"	2' 8-3/4"	108	74
5 S	0	1' 10"	3' 8-1/4"	11"	0"	0"	180	85
5 S	15 W	1' 10"	3' 8-1/4"	11"	5' 5-1/2"	2' 8-3/4"	252	74
5 S	30 W	1' 10"	3' 8-1/4"	11"	10' 6-3/4"	5' 3-1/4"	261	60
5 S	45 W	1' 10"	3' 8-1/4"	11"	14' 11-1/4"	7' 5-1/2"	265	45
5 S	60 W	1' 10"	3' 8-1/4"	11"	18' 3-1/2"	9' 1-3/4"	267	30



AJ4CO Observatory Diagram

SIZE A	DATE 01 OCT 2014	PART NUMBER N/A	REV
SCALE NONE	DRAWN BY DAVE TYPINSKI	SHEET 7 OF 11	

TFD Array Beam Steering

Time Delay Cable VoP: 66% **Array elements N-S baseline spacing (feet): 32**
Array elements E-W baseline spacing (feet): 32

N-S Offset (degrees)	E-W Offset (degrees)	Delay Cable Lengths (feet & inches)					AZ (degrees)	EL (degrees)
		A (S) / B (N)	C (S) / D (N)	E	F (W) / G (E)	H		
10 S	60 E	3' 8"	7' 4"	1' 10"	18' 3-1/2"	9' 1-3/4"	96	30
10 S	45 E	3' 8"	7' 4"	1' 10"	14' 11-1/4"	7' 5-1/2"	100	45
10 S	30 E	3' 8"	7' 4"	1' 10"	10' 6-3/4"	5' 3-1/4"	107	59
10 S	15 E	3' 8"	7' 4"	1' 10"	5' 5-1/2"	2' 8-3/4"	123	72
10 S	0	3' 8"	7' 4"	1' 10"	0"	0"	180	80
10 S	15 W	3' 8"	7' 4"	1' 10"	5' 5-1/2"	2' 8-3/4"	237	72
10 S	30 W	3' 8"	7' 4"	1' 10"	10' 6-3/4"	5' 3-1/4"	253	59
10 S	45 W	3' 8"	7' 4"	1' 10"	14' 11-1/4"	7' 5-1/2"	260	45
10 S	60 W	3' 8"	7' 4"	1' 10"	18' 3-1/2"	9' 1-3/4"	264	30
<hr/>								
15 S	60 E	5' 5-1/2"	10' 11-1/4"	2' 8-3/4"	18' 3-1/2"	9' 1-3/4"	99	30
15 S	45 E	5' 5-1/2"	10' 11-1/4"	2' 8-3/4"	14' 11-1/4"	7' 5-1/2"	105	44
15 S	30 E	5' 5-1/2"	10' 11-1/4"	2' 8-3/4"	10' 6-3/4"	5' 3-1/4"	115	58
15 S	15 E	5' 5-1/2"	10' 11-1/4"	2' 8-3/4"	5' 5-1/2"	2' 8-3/4"	135	69
15 S	0	5' 5-1/2"	10' 11-1/4"	2' 8-3/4"	0"	0"	180	75
15 S	15 W	5' 5-1/2"	10' 11-1/4"	2' 8-3/4"	5' 5-1/2"	2' 8-3/4"	225	69
15 S	30 W	5' 5-1/2"	10' 11-1/4"	2' 8-3/4"	10' 6-3/4"	5' 3-1/4"	245	58
15 S	45 W	5' 5-1/2"	10' 11-1/4"	2' 8-3/4"	14' 11-1/4"	7' 5-1/2"	255	44
15 S	60 W	5' 5-1/2"	10' 11-1/4"	2' 8-3/4"	18' 3-1/2"	9' 1-3/4"	261	30
<hr/>								
20 S	60 E	7' 2-3/4"	14' 5-1/4"	3' 7-1/4"	18' 3-1/2"	9' 1-3/4"	102	29
20 S	45 E	7' 2-3/4"	14' 5-1/4"	3' 7-1/4"	14' 11-1/4"	7' 5-1/2"	110	43
20 S	30 E	7' 2-3/4"	14' 5-1/4"	3' 7-1/4"	10' 6-3/4"	5' 3-1/4"	122	56
20 S	15 E	7' 2-3/4"	14' 5-1/4"	3' 7-1/4"	5' 5-1/2"	2' 8-3/4"	144	66
20 S	0	7' 2-3/4"	14' 5-1/4"	3' 7-1/4"	0"	0"	180	70
20 S	15 W	7' 2-3/4"	14' 5-1/4"	3' 7-1/4"	5' 5-1/2"	2' 8-3/4"	216	66
20 S	30 W	7' 2-3/4"	14' 5-1/4"	3' 7-1/4"	10' 6-3/4"	5' 3-1/4"	238	56
20 S	45 W	7' 2-3/4"	14' 5-1/4"	3' 7-1/4"	14' 11-1/4"	7' 5-1/2"	250	43
20 S	60 W	7' 2-3/4"	14' 5-1/4"	3' 7-1/4"	18' 3-1/2"	9' 1-3/4"	258	29



AJ4CO Observatory Diagram

SIZE A	DATE 01 OCT 2014	PART NUMBER N/A	REV
SCALE NONE	DRAWN BY DAVE TYPINSKI	SHEET 8 OF 11	

TFD Array Beam Steering

Time Delay Cable VoP: **66%** Array elements N-S baseline spacing (feet): **32**
 Array elements E-W baseline spacing (feet): **32**

N-S Offset (degrees)	E-W Offset (degrees)	Delay Cable Lengths (feet & inches)					AZ (degrees)	EL (degrees)
		A (S) / B (N)	C (S) / D (N)	E	F (W) / G (E)	H		
25 S	60 E	8' 11"	17' 10-1/4"	4' 5-1/2"	18' 3-1/2"	9' 1-3/4"	105	29
25 S	45 E	8' 11"	17' 10-1/4"	4' 5-1/2"	14' 11-1/4"	7' 5-1/2"	115	42
25 S	30 E	8' 11"	17' 10-1/4"	4' 5-1/2"	10' 6-3/4"	5' 3-1/4"	129	53
25 S	15 E	8' 11"	17' 10-1/4"	4' 5-1/2"	5' 5-1/2"	2' 8-3/4"	150	62
25 S	0	8' 11"	17' 10-1/4"	4' 5-1/2"	0"	0"	180	65
25 S	15 W	8' 11"	17' 10-1/4"	4' 5-1/2"	5' 5-1/2"	2' 8-3/4"	210	62
25 S	30 W	8' 11"	17' 10-1/4"	4' 5-1/2"	10' 6-3/4"	5' 3-1/4"	231	53
25 S	45 W	8' 11"	17' 10-1/4"	4' 5-1/2"	14' 11-1/4"	7' 5-1/2"	245	42
25 S	60 W	8' 11"	17' 10-1/4"	4' 5-1/2"	18' 3-1/2"	9' 1-3/4"	255	29
<hr/>								
30 S	60 E	10' 6-3/4"	21' 1-1/2"	5' 3-1/4"	18' 3-1/2"	9' 1-3/4"	108	29
30 S	45 E	10' 6-3/4"	21' 1-1/2"	5' 3-1/4"	14' 11-1/4"	7' 5-1/2"	120	41
30 S	30 E	10' 6-3/4"	21' 1-1/2"	5' 3-1/4"	10' 6-3/4"	5' 3-1/4"	135	51
30 S	15 E	10' 6-3/4"	21' 1-1/2"	5' 3-1/4"	5' 5-1/2"	2' 8-3/4"	155	58
30 S	0	10' 6-3/4"	21' 1-1/2"	5' 3-1/4"	0"	0"	180	60
30 S	15 W	10' 6-3/4"	21' 1-1/2"	5' 3-1/4"	5' 5-1/2"	2' 8-3/4"	205	58
30 S	30 W	10' 6-3/4"	21' 1-1/2"	5' 3-1/4"	10' 6-3/4"	5' 3-1/4"	225	51
30 S	45 W	10' 6-3/4"	21' 1-1/2"	5' 3-1/4"	14' 11-1/4"	7' 5-1/2"	240	41
30 S	60 W	10' 6-3/4"	21' 1-1/2"	5' 3-1/4"	18' 3-1/2"	9' 1-3/4"	252	29
<hr/>								
35 S	60 E	12' 1-1/4"	24' 2-3/4"	6' 0-3/4"	18' 3-1/2"	9' 1-3/4"	112	28
35 S	45 E	12' 1-1/4"	24' 2-3/4"	6' 0-3/4"	14' 11-1/4"	7' 5-1/2"	125	39
35 S	30 E	12' 1-1/4"	24' 2-3/4"	6' 0-3/4"	10' 6-3/4"	5' 3-1/4"	140	48
35 S	15 E	12' 1-1/4"	24' 2-3/4"	6' 0-3/4"	5' 5-1/2"	2' 8-3/4"	159	53
35 S	0	12' 1-1/4"	24' 2-3/4"	6' 0-3/4"	0"	0"	180	55
35 S	15 W	12' 1-1/4"	24' 2-3/4"	6' 0-3/4"	5' 5-1/2"	2' 8-3/4"	201	53
35 S	30 W	12' 1-1/4"	24' 2-3/4"	6' 0-3/4"	10' 6-3/4"	5' 3-1/4"	220	48
35 S	45 W	12' 1-1/4"	24' 2-3/4"	6' 0-3/4"	14' 11-1/4"	7' 5-1/2"	235	39
35 S	60 W	12' 1-1/4"	24' 2-3/4"	6' 0-3/4"	18' 3-1/2"	9' 1-3/4"	248	28



AJ4CO Observatory Diagram

SIZE A	DATE 01 OCT 2014	PART NUMBER N/A	REV
SCALE NONE	DRAWN BY DAVE TYPINSKI	SHEET 9 OF 11	

TFD Array Beam Steering

Time Delay Cable VoP: 66% **Array elements N-S baseline spacing (feet): 32**
Array elements E-W baseline spacing (feet): 32

N-S Offset (degrees)	E-W Offset (degrees)	Delay Cable Lengths (feet & inches)					AZ (degrees)	EL (degrees)
		A (S) / B (N)	C (S) / D (N)	E	F (W) / G (E)	H		
40 S	60 E	13' 7"	27' 1-3/4"	6' 9-1/2"	18' 3-1/2"	9' 1-3/4"	116	27
40 S	45 E	13' 7"	27' 1-3/4"	6' 9-1/2"	14' 11-1/4"	7' 5-1/2"	130	37
40 S	30 E	13' 7"	27' 1-3/4"	6' 9-1/2"	10' 6-3/4"	5' 3-1/4"	145	44
40 S	15 E	13' 7"	27' 1-3/4"	6' 9-1/2"	5' 5-1/2"	2' 8-3/4"	162	49
40 S	0	13' 7"	27' 1-3/4"	6' 9-1/2"	0"	0"	180	50
40 S	15 W	13' 7"	27' 1-3/4"	6' 9-1/2"	5' 5-1/2"	2' 8-3/4"	198	49
40 S	30 W	13' 7"	27' 1-3/4"	6' 9-1/2"	10' 6-3/4"	5' 3-1/4"	215	44
40 S	45 W	13' 7"	27' 1-3/4"	6' 9-1/2"	14' 11-1/4"	7' 5-1/2"	230	37
40 S	60 W	13' 7"	27' 1-3/4"	6' 9-1/2"	18' 3-1/2"	9' 1-3/4"	244	27
<hr/>								
45 S	60 E	14' 11-1/4"	29' 10-1/2"	7' 5-1/2"	18' 3-1/2"	9' 1-3/4"	120	27
45 S	45 E	14' 11-1/4"	29' 10-1/2"	7' 5-1/2"	14' 11-1/4"	7' 5-1/2"	135	35
45 S	30 E	14' 11-1/4"	29' 10-1/2"	7' 5-1/2"	10' 6-3/4"	5' 3-1/4"	150	41
45 S	15 E	14' 11-1/4"	29' 10-1/2"	7' 5-1/2"	5' 5-1/2"	2' 8-3/4"	165	44
45 S	0	14' 11-1/4"	29' 10-1/2"	7' 5-1/2"	0"	0"	180	45
45 S	15 W	14' 11-1/4"	29' 10-1/2"	7' 5-1/2"	5' 5-1/2"	2' 8-3/4"	195	44
45 S	30 W	14' 11-1/4"	29' 10-1/2"	7' 5-1/2"	10' 6-3/4"	5' 3-1/4"	210	41
45 S	45 W	14' 11-1/4"	29' 10-1/2"	7' 5-1/2"	14' 11-1/4"	7' 5-1/2"	225	35
45 S	60 W	14' 11-1/4"	29' 10-1/2"	7' 5-1/2"	18' 3-1/2"	9' 1-3/4"	240	27
<hr/>								
50 S	60 E	16' 2-1/4"	32' 4-1/4"	8' 1"	18' 3-1/2"	9' 1-3/4"	125	25
50 S	45 E	16' 2-1/4"	32' 4-1/4"	8' 1"	14' 11-1/4"	7' 5-1/2"	140	33
50 S	30 E	16' 2-1/4"	32' 4-1/4"	8' 1"	10' 6-3/4"	5' 3-1/4"	154	37
50 S	15 E	16' 2-1/4"	32' 4-1/4"	8' 1"	5' 5-1/2"	2' 8-3/4"	167	39
50 S	0	16' 2-1/4"	32' 4-1/4"	8' 1"	0"	0"	180	40
50 S	15 W	16' 2-1/4"	32' 4-1/4"	8' 1"	5' 5-1/2"	2' 8-3/4"	193	39
50 S	30 W	16' 2-1/4"	32' 4-1/4"	8' 1"	10' 6-3/4"	5' 3-1/4"	206	37
50 S	45 W	16' 2-1/4"	32' 4-1/4"	8' 1"	14' 11-1/4"	7' 5-1/2"	220	33
50 S	60 W	16' 2-1/4"	32' 4-1/4"	8' 1"	18' 3-1/2"	9' 1-3/4"	235	25



AJ4CO Observatory Diagram

SIZE A	DATE 01 OCT 2014	PART NUMBER N/A	REV
SCALE NONE	DRAWN BY DAVE TYPINSKI	SHEET 10 OF 11	

TFD Array Beam Steering

Time Delay Cable VoP: **66%** Array elements N-S baseline spacing (feet): **32**
 Array elements E-W baseline spacing (feet): **32**

N-S Offset (degrees)	E-W Offset (degrees)	Delay Cable Lengths (feet & inches)					AZ (degrees)	EL (degrees)
		A (S) / B (N)	C (S) / D (N)	E	F (W) / G (E)	H		
55 S	60 E	17' 3-1/2"	34' 7-1/4"	8' 7-3/4"	18' 3-1/2"	9' 1-3/4"	130	24
55 S	45 E	17' 3-1/2"	34' 7-1/4"	8' 7-3/4"	14' 11-1/4"	7' 5-1/2"	145	30
55 S	30 E	17' 3-1/2"	34' 7-1/4"	8' 7-3/4"	10' 6-3/4"	5' 3-1/4"	158	33
55 S	15 E	17' 3-1/2"	34' 7-1/4"	8' 7-3/4"	5' 5-1/2"	2' 8-3/4"	169	35
55 S	0	17' 3-1/2"	34' 7-1/4"	8' 7-3/4"	0"	0"	180	35
55 S	15 W	17' 3-1/2"	34' 7-1/4"	8' 7-3/4"	5' 5-1/2"	2' 8-3/4"	191	35
55 S	30 W	17' 3-1/2"	34' 7-1/4"	8' 7-3/4"	10' 6-3/4"	5' 3-1/4"	202	33
55 S	45 W	17' 3-1/2"	34' 7-1/4"	8' 7-3/4"	14' 11-1/4"	7' 5-1/2"	215	30
55 S	60 W	17' 3-1/2"	34' 7-1/4"	8' 7-3/4"	18' 3-1/2"	9' 1-3/4"	230	24
<hr/>								
60 S	60 E	18' 3-1/2"	36' 7"	9' 1-3/4"	18' 3-1/2"	9' 1-3/4"	135	22
60 S	45 E	18' 3-1/2"	36' 7"	9' 1-3/4"	14' 11-1/4"	7' 5-1/2"	150	27
60 S	30 E	18' 3-1/2"	36' 7"	9' 1-3/4"	10' 6-3/4"	5' 3-1/4"	162	29
60 S	15 E	18' 3-1/2"	36' 7"	9' 1-3/4"	5' 5-1/2"	2' 8-3/4"	171	30
60 S	0	18' 3-1/2"	36' 7"	9' 1-3/4"	0"	0"	180	30
60 S	15 W	18' 3-1/2"	36' 7"	9' 1-3/4"	5' 5-1/2"	2' 8-3/4"	189	30
60 S	30 W	18' 3-1/2"	36' 7"	9' 1-3/4"	10' 6-3/4"	5' 3-1/4"	198	29
60 S	45 W	18' 3-1/2"	36' 7"	9' 1-3/4"	14' 11-1/4"	7' 5-1/2"	210	27
60 S	60 W	18' 3-1/2"	36' 7"	9' 1-3/4"	18' 3-1/2"	9' 1-3/4"	225	22



AJ4CO Observatory Diagram

SIZE A	DATE 01 OCT 2014	PART NUMBER N/A	REV
SCALE NONE	DRAWN BY DAVE TYPINSKI	SHEET 11 OF 11	

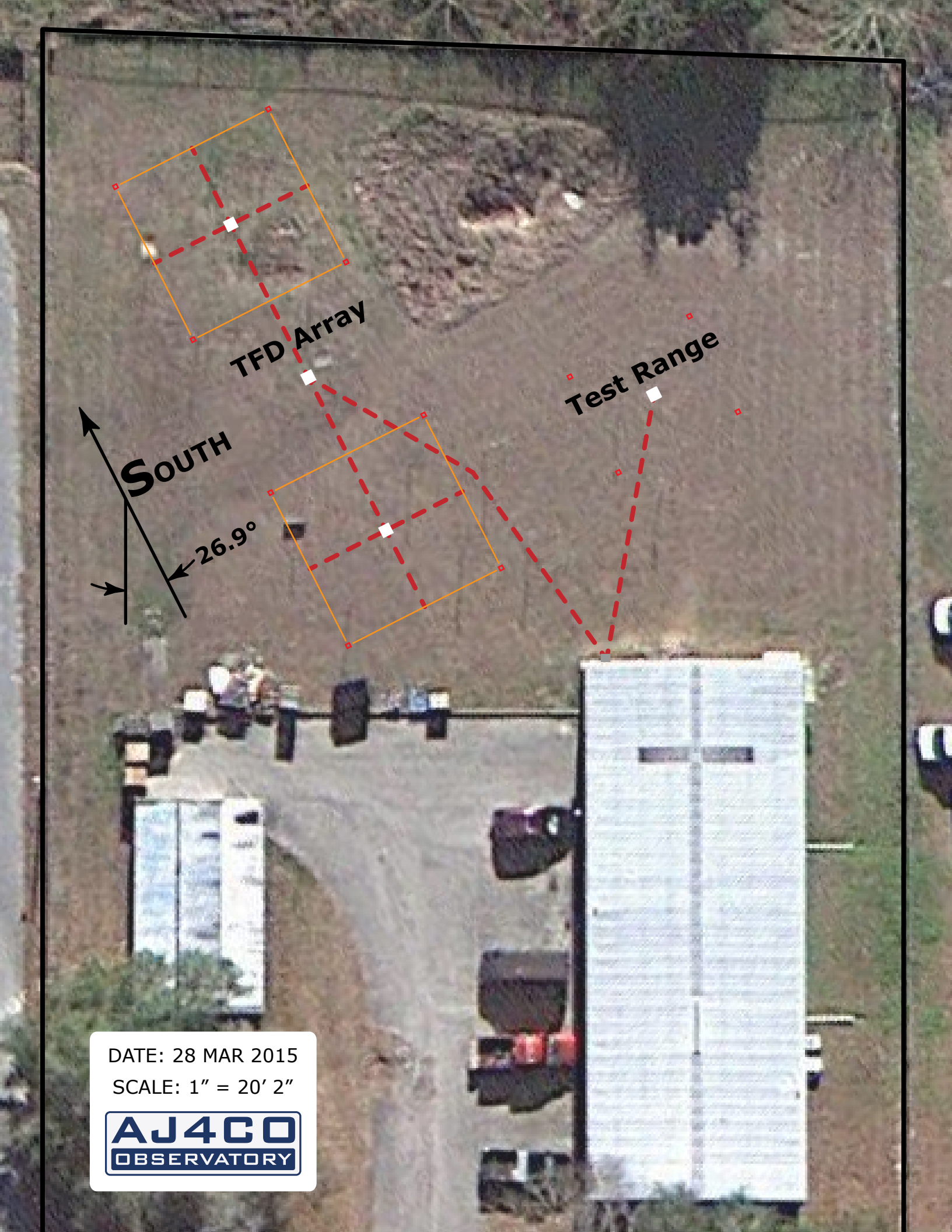

TFD Array

Test Range

SOUTH

26.9°

DATE: 28 MAR 2015
SCALE: 1" = 20' 2"



UFRO

AJ400
OBSERVATORY

LGM

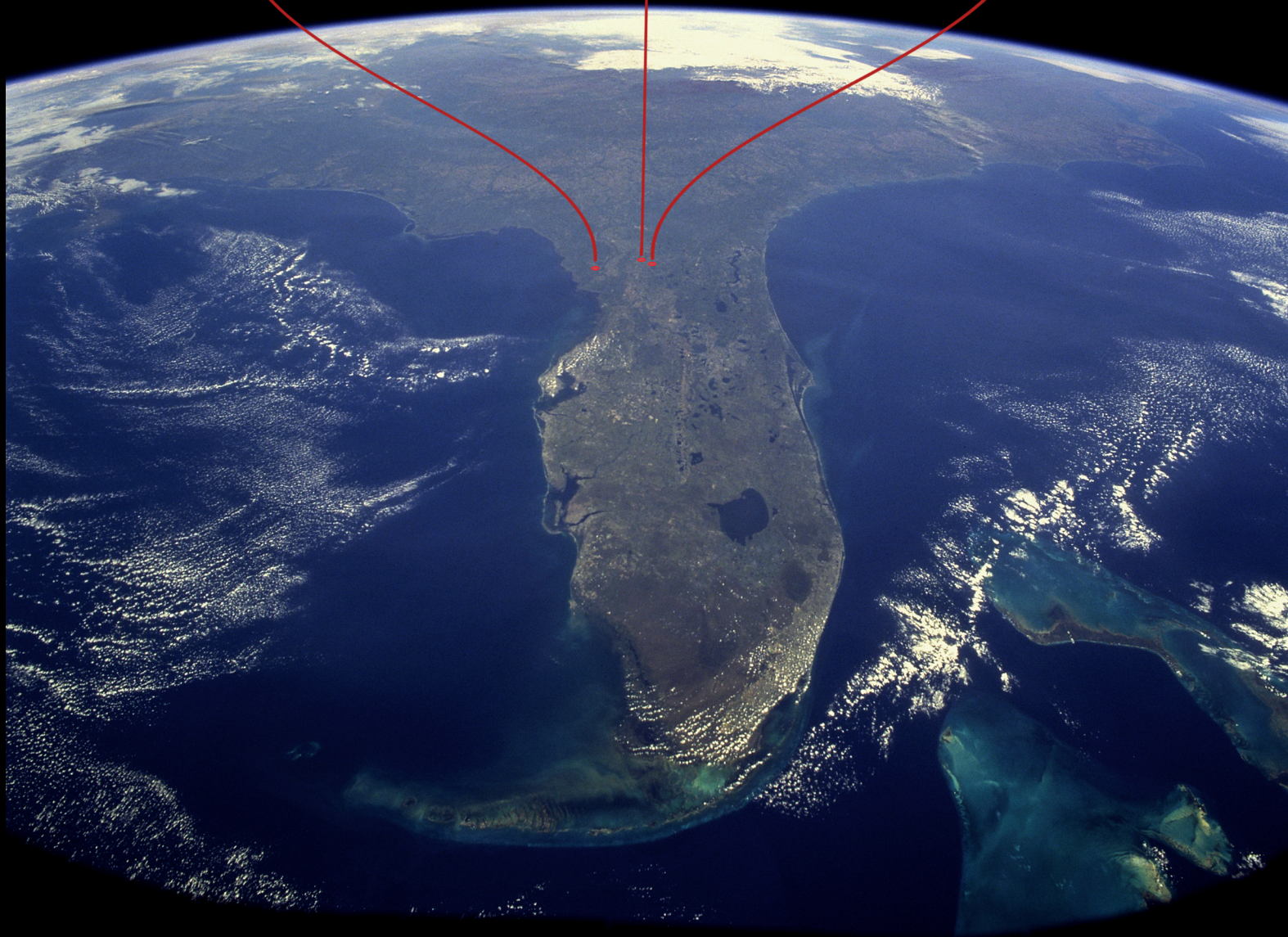

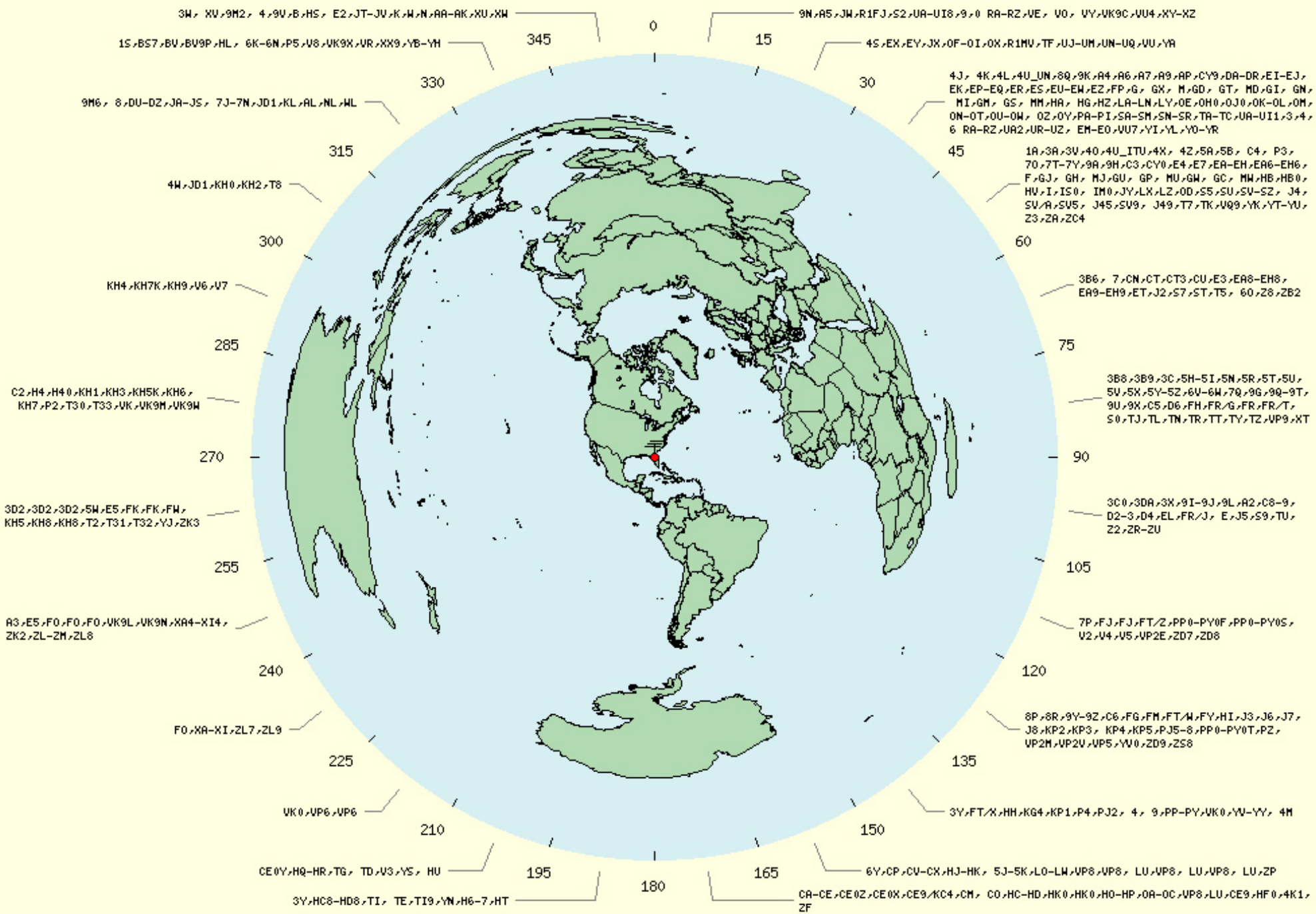



Find the magnetic declination at your location

Find your location or click on the map to display your magnetic declination

[Browse countries](#) [What is Magnetic Declination?](#)

Sites of Interest

[Real Time Cinema](#)

[Satellite tracking](#)

[Radio Astronomy](#)

Find your location

high springs

USA

FLORIDA

::SEARCH MAP::

[Browse countries](#)

1 HIGH SPRINGS FL

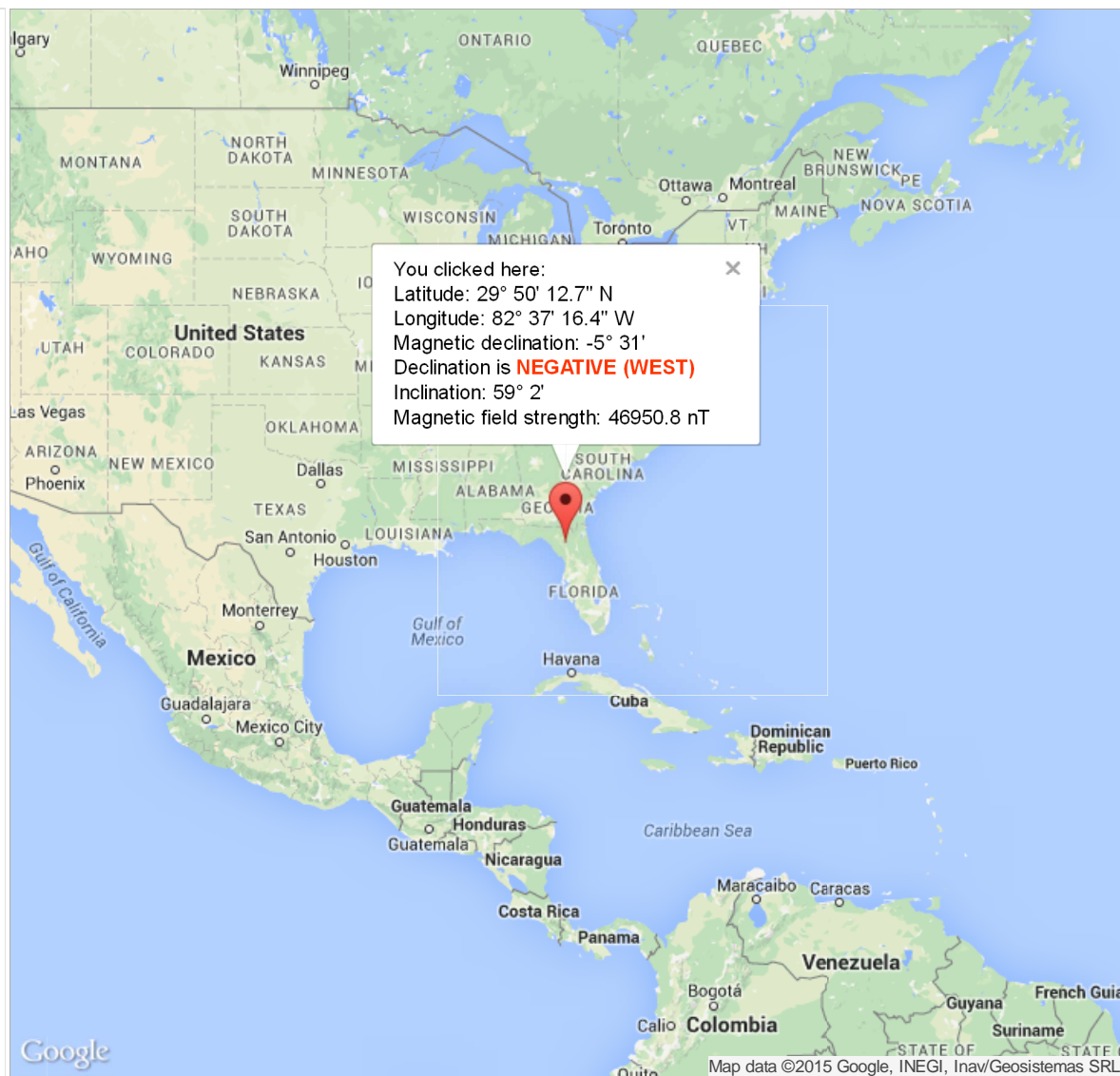

Copyright ©2015 Magnetic-Declination.com
Questions? webmaster@magnetic-declination.com



**Check your
declination**

Find the magnetic declination at your location

What is Magnetic Declination?

Did you know that magnetic compass does not always point to North? Actually, there are only a few locations on Earth where it points exactly to the True (geographic) North. The direction in which the compass needle points is known as Magnetic North, and the angle between Magnetic North and the True North direction is called **magnetic declination**.

Magnetic declination varies both from place to place, and with the passage of time. As a traveller cruises the east coast of the United States, for example, the declination varies from 20 degrees west (in Maine) to zero (in Florida), to 10 degrees east (in Texas), meaning a compass adjusted at the beginning of the journey would have a true north error of over 30 degrees if not adjusted for the changing declination. The magnetic declination in a given area will change slowly over time, possibly as much as 2-25 degrees every hundred years or so, depending upon how far from the magnetic poles it is. Complex fluid motion in the outer core of the Earth (the molten metallic region that lies from 2800 to 5000 km below the Earth's surface) causes the magnetic field to change slowly with time. This change is known as secular variation. Because of secular variation, declination values shown on old topographic, marine and aeronautical charts need to be updated if they are to be used without large errors. Unfortunately, the annual change corrections given on most of these maps cannot be applied reliably if the maps are more than a few years old since the secular variation also changes with time in an unpredictable manner.

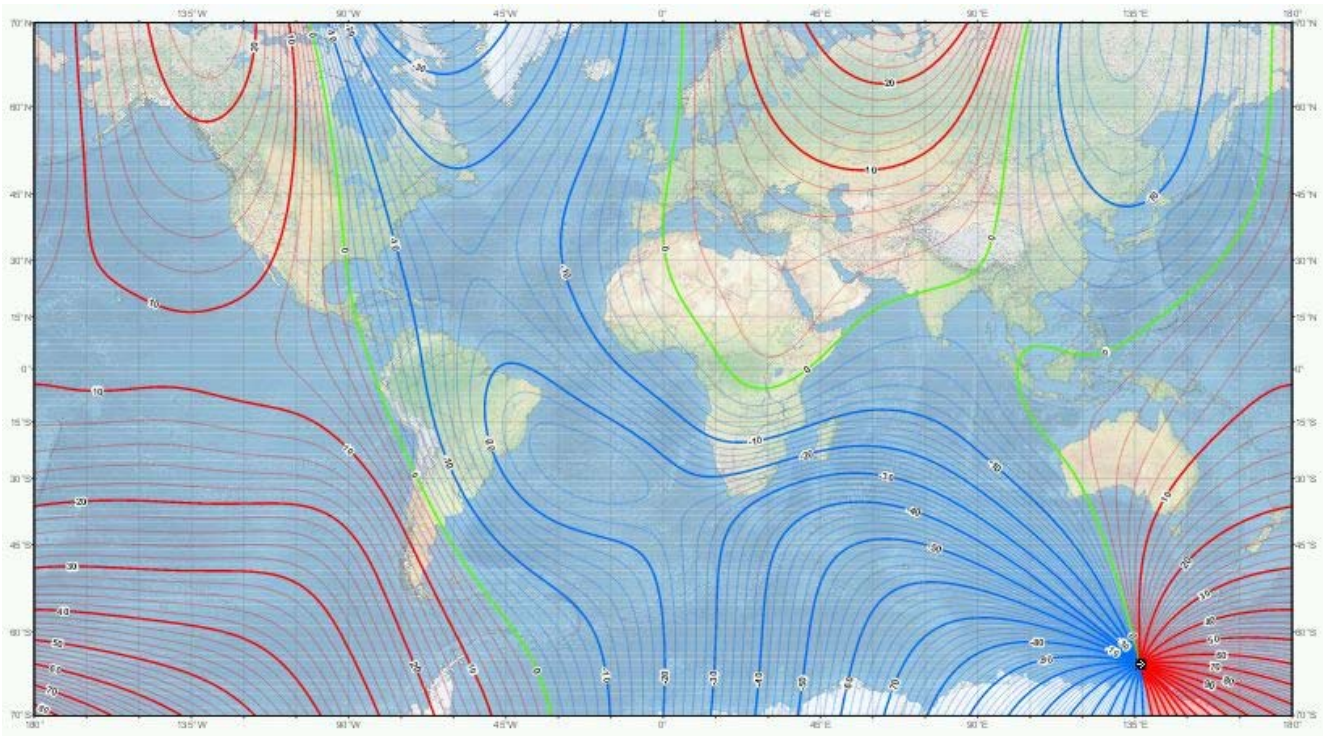

If the compass at your place is pointing **clockwise** with respect to the True North, declination is **positive** or **EAST**

If the compass at your place is pointing **counter-clockwise** with respect to the True North, declination is **negative** or **WEST**

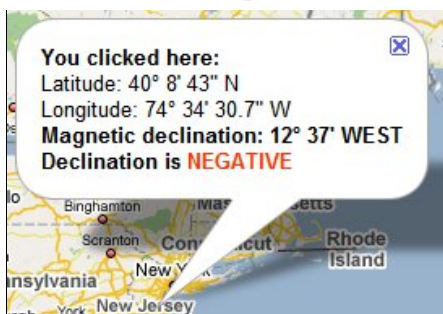
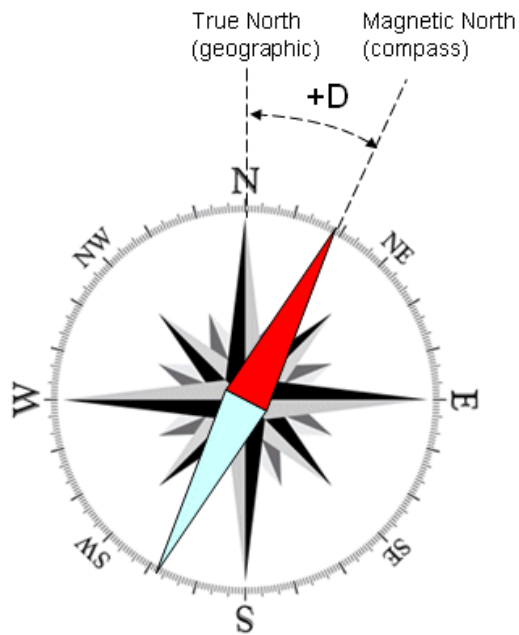
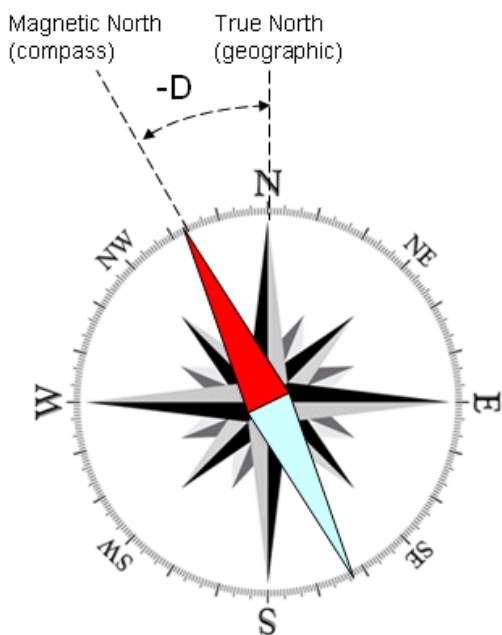

Negative declination (WEST)

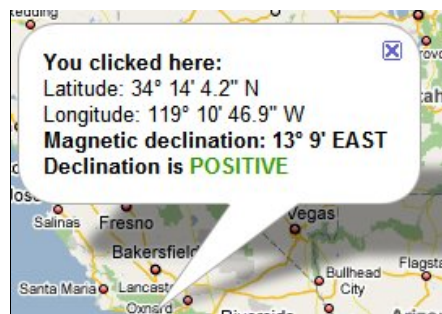

Positive declination (EAST)

How can we calculate declination at any given place?

One way would be to use declination maps. Unfortunately because of secular variation, declination values are constantly changing. When printed maps were the only way of getting this information, the declination values were somewhat out of date by the time the maps got to the general public.

Another way would be to perform a prediction. This should be based on a world-wide empirical model of the deep flows. This [web page](#) operated by the National Geophysical Data Center (NDGC) offers a pretty good value for declination. The model reflects a highly predictable rate of change, and will usually be more accurate than a map, and almost never less accurate.

The best way however is to use [the current web site](#), which offers in a graphical format using Google Maps API the computed declination for any place on Earth. The algorithm implements the [World Magnetic Model WMM2015](#).



Copyright ©2015 Magnetic-Declination.com
 Questions? webmaster@magnetic-declination.com

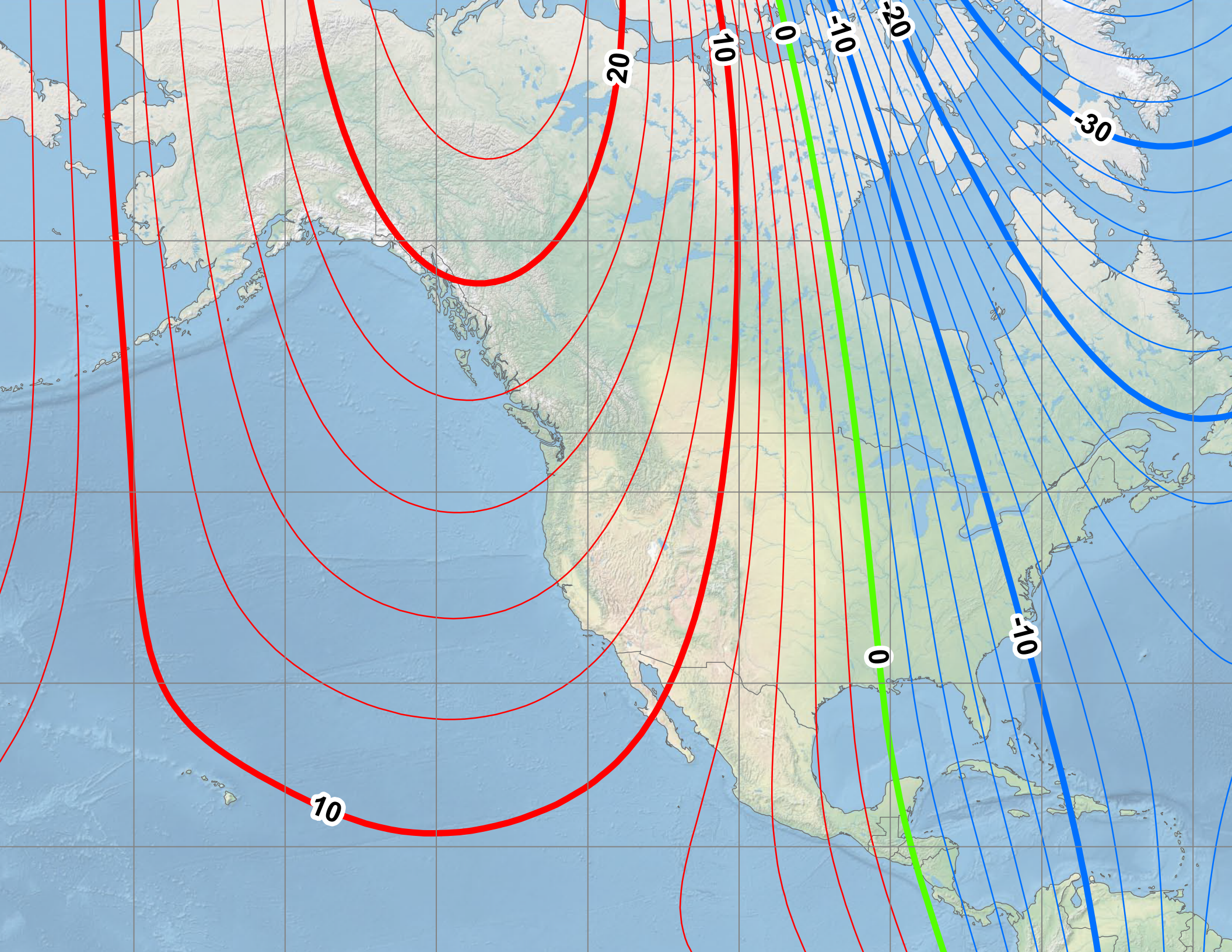

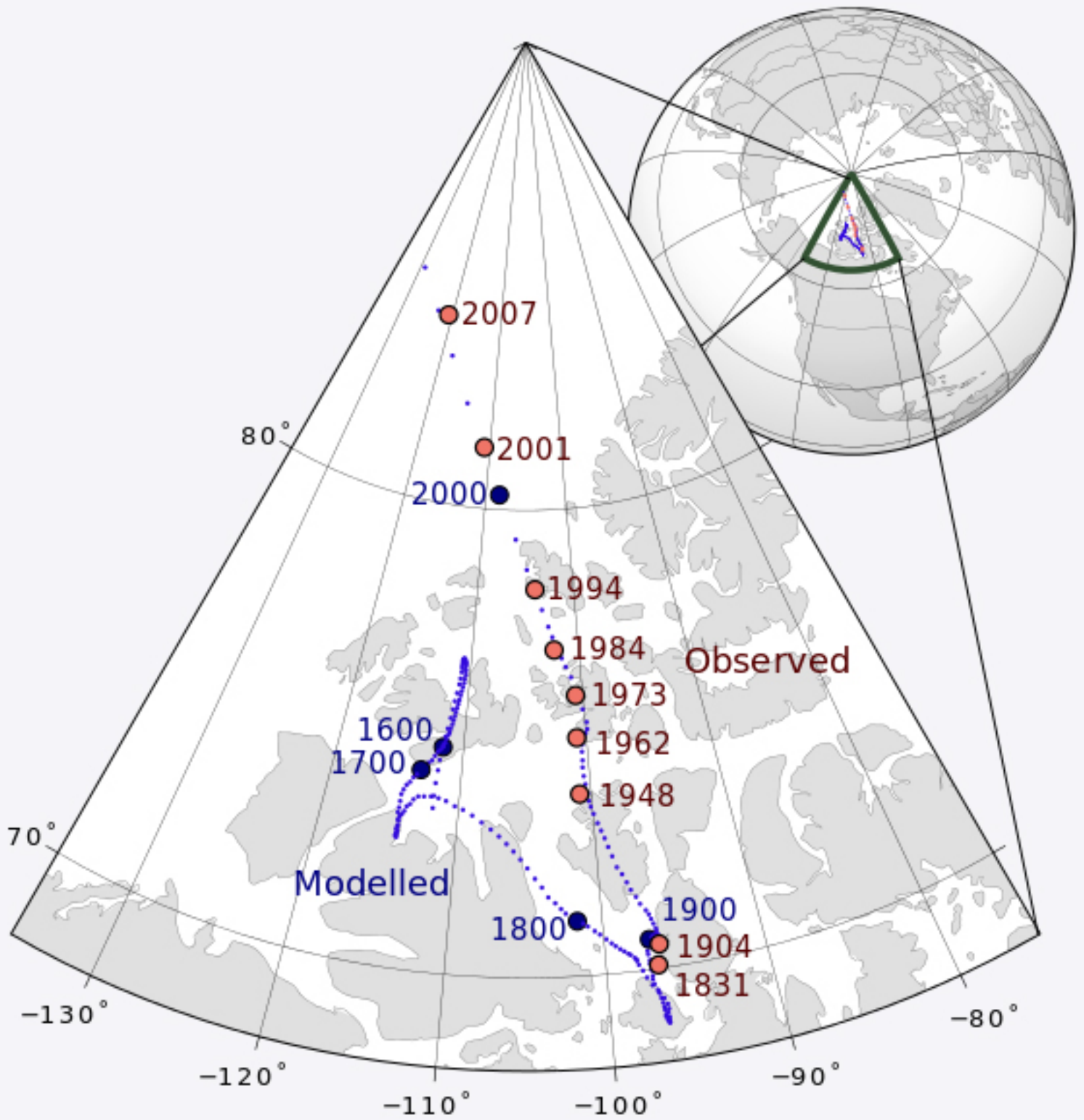

https://en.wikipedia.org/wiki/North_Magnetic_Pole#/media/File:Magnetic_North_Pole_Positions.svg

Dipole Array Estimation of Directivity, Aperture, and HPBW
Assuming beam steered to zenith, no sidelobes, and circular pattern
 Typinski, 2015

Elements (n)	Linear Polarized Arrays In Free Space		Linear Polarized Arrays Above Perfect Ground Plane				Effective Aperture at f = 20.0 MHz (m ²)	zenith beam no sidelobes circular pattern HPBW θ (degs)	Circular Polarized Arrays of Orthogonal Linear Elements Above Perfect Ground Plane Receiving 100% CP Emissions		Effective Aperture at 20.0 MHz (m ²)
	D (dBi)	D (dBd)	D (dBi)	D (dBd)	D (dBi)	D (dBic)					
1	2.2	0	5.2	3	59	134	—	—	—		
2	5.2	3	8.2	6	117	92	11.2	8.2	233		
4	8.2	6	11.2	9	233	64	14.2	11.2	465		
8	11.2	9	14.2	12	465	45	17.2	14.2	928		
16	14.2	12	17.2	15	928	32	20.2	17.2	1,851		
32	17.2	15	20.2	18	1,851	23	23.2	20.2	3,693		
64	20.2	18	23.2	21	3,693	16	26.2	23.2	7,368		
128	23.2	21	26.2	24	7,368	11	29.2	26.2	14,702		
256	26.2	24	29.2	27	14,702	8	32.2	29.2	29,334		
512	29.2	27	32.2	30	29,334	6	35.2	32.2	58,529		
1,024	32.2	30	35.2	33	58,529	4	38.2	35.2	116,781		
2,048	35.2	33	38.2	36	116,781	3	41.2	38.2	233,008		
640	30.1	28	33.1	31	36,640	5	36.1	33.1	73,105		

= dBd + 2.15 = 3 log₂ n

= free space + 3dB

$$= \frac{D_{dBi} \lambda^2}{4\pi}$$

$$dBi = 10 \log \left(\frac{4\pi}{\Omega} \right)$$

$$\Omega = 2\pi \left(1 - \cos \frac{\theta_{HPBW}}{2} \right)$$

$$\theta_{HPBW} = 2 \cos^{-1} \left[1 - 2 \left(10^{-\frac{dBi}{10}} \right) \right]$$

= D_{free space} + 6dB
 3 dB for ground plane
 3 dB for CP emission

= dBi - 3dB

$$= \frac{D_{dBi} \lambda^2}{4\pi}$$